



coatmaster

measure up. contactless.



coatmaster.com/flex-start



PATENTED
TECHNOLOGY

coatmaster Flex User Manual

coatmaster.com

Version: **05-2024**

State: 24.05.2024











© 2019-2024 coatmaster AG

Distribution and duplication of this document, and utilization and communication of its contents other than for legitimate purposes, are not permitted without the express permission of coatmaster AG. Violations will result in legal action.

All rights are reserved in the event of patent grant or utility model registration (ISO 16016).

Subject to technical changes and printing errors, the values given are approximate and are not to be understood as legally warranted characteristics. These values may vary according to component tolerance.

Last update: **05/2024**

Table of contents

1.	Technical Data	5
2.	Customer Requirements and Device Specification	6
3.	Applications	7
4.	Functionality and Measuring Principle	8
5.	Safety and Responsibility.....	9
5.1.	Warning Symbols	9
5.2.	Signs and Icons	10
5.3.	Improper Use	11
5.4.	Product Safety	12
5.5.	Compatibility with flame detectors	12
6.	Delivery Scope.....	13
7.	Set-Up	14
7.1.	Battery.....	15
7.1.1.	Battery Charging	15
7.1.2.	Battery Installation.....	16
7.2.	Navigation Panel.....	16
7.3.	Turning the Power On/Off.....	16
7.4.	Language Selection.....	17
7.5.	Wi-Fi Settings	17
7.6.	Activation.....	20
7.7.	Operation with coatmaster® Local server	22
8.	Operating Instructions	23
8.1.	System Settings.....	23
8.1.1.	Network Troubleshooter.....	24
8.1.2.	Select license and server.....	24
8.1.3.	User Level.....	25
8.1.4.	Measurement Unit.....	26
8.1.5.	Auto power off.....	26
8.1.6.	Contact information	27
8.1.7.	Factory Reset	27
8.1.8.	Automation mode.....	28
8.2.	Main Menu.....	29
8.3.	Block Menu.....	30
8.3.1.	Select a block.....	30
8.3.2.	Create a new block	31
8.3.3.	Rename a block.....	32
8.3.4.	Remove a block.....	33
8.3.5.	Favorite a block.....	34

8.4.	Application Menu	34
8.4.1.	Delete an application	36
8.4.2.	Favorite an application	37
8.4.3.	Advanced calibration report.....	38
8.4.4.	Calibration Menu	38
8.4.5.	Quick Application	39
8.4.6.	Manual Application.....	39
8.4.7.	Reference Measurements	41
8.4.8.	Calibration Report.....	44
8.4.9.	Rename application.....	45
8.4.10.	Edit Materials Properties or DisplayOptions	46
8.4.11.	Materials Properties.....	47
8.4.12.	Display Options.....	47
8.4.13.	Display Options (Bounds).....	48
8.4.14.	Example of a Calibration Process	51
8.4.15.	Offset calibration.....	52
9.	Measurement.....	53
10.	Data Transfer/Cloud.....	55
10.1.	Login.....	55
10.1.1.	Applications.....	57
10.1.2.	Monitor	57
10.1.3.	Export	58
10.1.4.	Help.....	59
11.	Troubleshooting and Best Practice	60
11.1.	Error Messages	60
11.2.	Error Codes	61
11.3.	Frequently Asked Questions (FAQs).....	63
11.4.	Hotline.....	63
12.	Storage and Transportation	64
13.	Maintenance and Repair	64
13.1.	Replacement of the Inlet Filter.....	65
13.2.	Cleaning and Care.....	65
13.3.	Warranty.....	65
14.	API-Interface Description	66

Foreword

Dear Customer,

with the purchase of a coatmaster® Flex, you have acquired a high-quality, precision product. In this manual we provide you with some instructions to help you to work successfully and productively with this device for many years. coatmaster AG has made every effort to manufacture a safe and high-quality device that complies with all applicable regulations. Our strict quality control procedures ensure high quality standards even for high volume production. Please apply your own controls and treat the device with care. Should you have any questions regarding the use of the equipment, please do not hesitate to contact us.

We wish you success and 'a perfect coating'.

The Founders Prof. Dr. N. A. Reinke and Andor Bariska
coatmaster AG



1. Technical Data

Characteristics	Tolerance/ Description
Measuring distance range	20 - 150 mm
Measurement angle / tolerance	±70°
Measuring point size	2 mm ² at 75 mm distance
Measuring range thickness	10 - 500 µm (depending on coating type)
Standard deviation	Typical < 2% of the thickness
Measuring time	Typical 300 ms (depending on setting for coating thickness)
Storage conditions	-10 - 50°C max. 80% humidity (non-condensing)
Power supply	Bosch GAL 18V-40 2x Bosch ProCore 18V, 4 Ah
Number of measurements	Up to 1.300 measurements per battery charge (4 Ah)
Operating conditions	Temperature: 0 - 35°C, Rel. humidity: 10% -75%
Weight (without battery)	1.3 kg
Dimensions	374 x 91 x 203 mm
IP protection type	IP50

Table 1: *Technical data*



2. Customer Requirements and Device Specification

Measuring the coating thickness early in the process is the key to documenting and controlling coating processes, saving coating material, improving coating quality, and reducing production time and scrap. Coating processes are highly sensitive to changes in environmental conditions; therefore, it is crucial to have access to a thickness gauge that is easy to operate and works well in an aggressive (dust, high temperature) industrial environment.

The patented measurement process used by the coatmaster® Flex is non-contact (as opposed to systems based on magnetic induction or ultrasound) and non-destructive. It can be applied on wet, powder, and cured coatings, regardless of the coating material, thickness, or color (including white). In contrast to magnetic induction-based systems, the Flex device permits measurement of coating thickness early in the process, i.e., directly after the application of the coating material, before drying or curing. This allows:

- Savings of 10% - 30% coating material
- Reducing time for color changes
- Accelerating training of new personnel
- Avoiding cost intensive rejects & reworks
- Documenting coating processes
- Reducing environmental impact
- Establishing industry 4.0 standards
- Online-connection to ERP-System

coatmaster® Flex is the most advanced measurement gauge for non-contact thickness measurements. It outperforms any other photothermal, LED/laser-based, and ultrasound systems on the market in all industrial relevant aspects. It requires minimal calibration and is insensitive to the angle and distance of measurement. Its superior reliability, user-friendliness, safe usage, cost-effectiveness, precision, and accuracy is highly appreciated by major coating-line manufacturers, large paint manufacturers, renowned experts and most importantly by coaters around the globe.

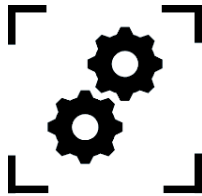



3. Applications

The coatmaster® Flex is a flexible and robust handheld device for non-contact measurement of coatings.

The coatmaster® Flex is unique and versatile and can be used in a wide variety of industries and industrial sectors:

<ul style="list-style-type: none"> • Automotive • Rail • Aerospace 	<ul style="list-style-type: none"> • Building Industry • Furniture • Profiles 	<ul style="list-style-type: none"> • Wind Power • Pipelines • Medical/Technical
---	--	--

The coatmaster® Flex is particularly suitable for the following applications:

Powder paints	
	<p>Due to control of coating thickness measurement with Flex, up to 30% of powder quantity can be saved. Measurement early in the process prior to curing also saves time and reduces rework rates.</p>
Wet paints	
	<p>Precise measurements are possible even before drying. The measuring equipment capability is guaranteed. This saves material and time and ensures quality.</p>
Functional coatings	
	<p>Thickness measurement of functional coatings (i.e., e-coats, adhesives, anti-corrosive coatings) in wet and dried state. Highly accurate measurement even on rough surfaces and for soft coatings.</p>

4. Functionality and Measuring Principle

The coatmaster® works according to the principle of advanced thermal optics (ATO). The surface of the coating is heated with a light pulse. After brief heating by a few degrees, the surface is cooled by heat conduction to deeper areas of the coating and the substrate. The cooling process on the surface depends on the thermal properties of the coating and the substrate. The thinner the coating, the faster the surface temperature decreases, provided it has a lower thermal conductivity than the substrate. The thickness and thermal properties of the coating are derived from the dynamics of the surface temperature.

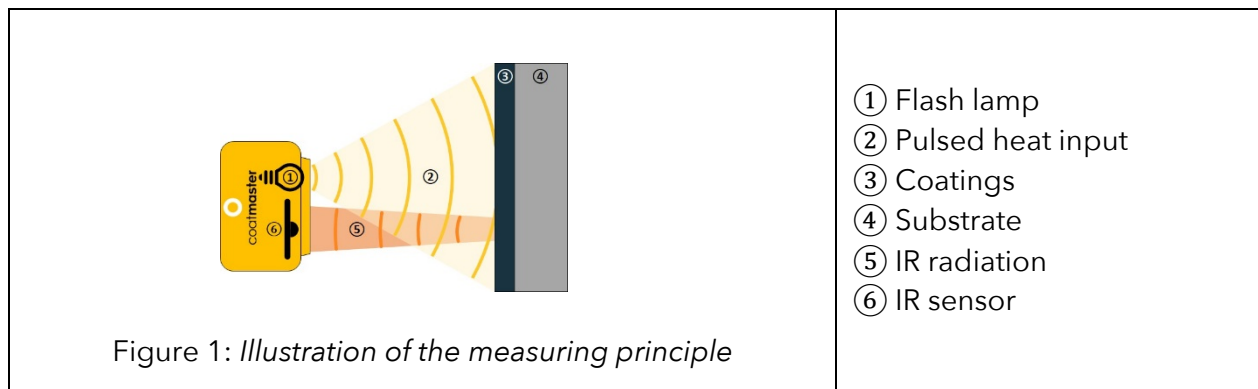

Generally, coatings have a very irregular surface. Powder coatings prior to curing have an even rougher surface but can nevertheless be measured with the coatmaster® Flex. The properties of this roughness are influenced by various factors, such as pre-treatment, the type and roughness of the substrate, the type of coating (e.g., particle size, distribution, and chemical composition), and the exact conditions (temperature distribution, baking time) during curing. The diagram below shows a microscopic sketch of this roughness. The ATO automatically compensates for the roughness described above, using an optical averaging process. This allows a reliable determination of the coating thickness, even with changing parameters.

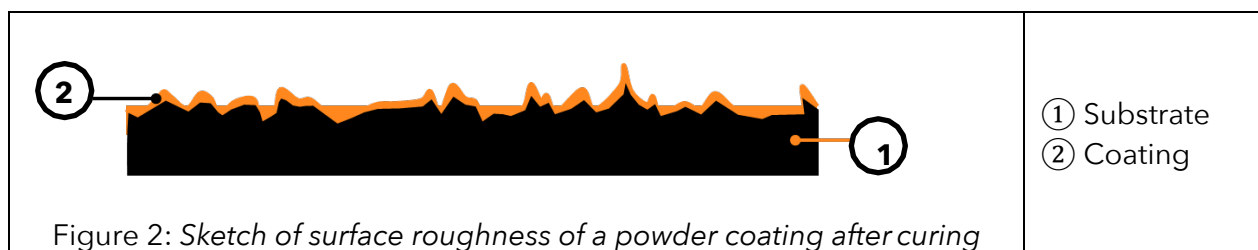



5. Safety and Responsibility

This section provides an overview of all relevant safety features for optimum personal protection and safe and trouble-free operation. Keep the operating instructions with the safety instructions so that you can refer to them later.

5.1. Warning Symbols

For your safety, it is important to read and fully understand the following table showing the different warning signs and their definitions!







Symbol	Definition
 DANGER	Warning of an immediate danger that, if not avoided, will result in death or very serious injury. <ul style="list-style-type: none"> Measures to avoid the danger.
 WARNING	Warning of an immediate danger that, if not avoided, will result in serious injury. <ul style="list-style-type: none"> Measures to avoid the danger.
 CAUTION	Indication of a hazardous situation that, if not avoided, may result in minor or moderate injury. <ul style="list-style-type: none"> Measures to avoid the situation.
	Warning of optical radiation.
	Warning of electrical voltage.
	Warning of hazards associated with charging batteries.
CAUTION	Indication of a hazardous situation that, if not avoided, may result in property damage; however, no action is required with regard to personal injury. <ul style="list-style-type: none"> Measures to avoid the damage.

Table 2: Warning symbols

5.2. Signs and Icons



Symbol	Definition
	This symbol means that your device meets the safety requirements of all applicable EU directives.
	This symbol means that you may only dispose the device at an approved local disposal site.
	Information: A highlight containing particularly important information for better understanding.

Table 3: Signs and icons

Intended Use

The coatmaster® Flex is intended exclusively for the measurement of coating thicknesses.

The device should only be used as a handheld device. The device should not be mounted on a robot or fixture or operated for an extended period of time.

The instrument may only be operated and cleaned by trained personnel. The intended use also includes compliance with these instructions and the maintenance intervals must be observed.

Have your device repaired only by qualified personnel and only with original spare parts. This ensures that the safety of the device is maintained.

The device is not approved for operation in environments with potentially explosive atmospheres.

Keep the device away from rain or moisture. Penetration of water into an electrical appliance increases the risk of electric shock. Do not place the measurement device in a place where components could come into contact with corrosive gases or salty air.

Do not block ventilation openings. The ventilation openings prevent the interior of the unit from overheating.

Remove the battery before cleaning. Do not use solvents for cleaning, to avoid damaging the housing surface. Use a clean, dry cloth.

In accordance with Directive 2012/19/EU, please take old parts to the appropriate recycling facilities for proper disposal, reprocessing, and reuse. Never throw electrical equipment into the household waste! By properly disposing of the electrical appliances, you help to protect valuable resources and prevent possible negative effects on health and the environment, which could otherwise occur due to improper waste disposal. Accessories and packaging should also be recycled in an environmentally friendly manner.

5.3. Improper Use

Use not mentioned above or use that does not comply with the technical specifications, is considered to be improper use. The operator is solely responsible for any damage caused by improper use.

The following applications are prohibited:

- Use of the equipment in environments where liquids may get into the device.
- Introduction of any objects into the coatmaster® Flex or similar devices.
- Unauthorized opening the device, other than for standard maintenance operations ([see section 13.](#)), voids the warranty and the manufacturer assumes no liability.

The following safety instructions point out dangers of a general nature that may occur when handling the device. The user must observe all the instructions listed to minimize possible hazards.

Additional warning messages can be found in this manual whenever the actions described could result in hazards.



Symbol	Description
	<p>Integrated light source.</p> <p>The coatmaster® Flex with SpectralBlue® contains a Xenon flash lamp. The Evaluation of the photobiological safety of a Xenon flashlight according to IEC-62471:2006 shows that the coatmaster® Flex flash lamp falls under the exempt group and thus does not pose any photobiological hazard.</p>
<p>CAUTION</p> <p>Device damage may occur if the battery is changed during operation.</p> <p>Never change the battery during operation, as this can lead to the device being damaged.</p> <p>Always switch off the device before changing the battery. </p>	

Table 4: Warning - improper use

5.4. Product Safety

The measuring device has been designed and built with the latest state-of-the-art technology; however, risks to users, property, and the environment may arise if the measurement device is used carelessly or improperly, for which coatmaster AG bears no responsibility.

The following applications are prohibited:

- Use of the equipment in environments where liquids may get into the device.
- Introduction of any objects into the coatmaster® Flex or similar devices.
- Unauthorized opening the device, other than for standard maintenance operations ([see section 13.](#)), voids the warranty and the manufacturer assumes no liability.

The measurement process is started by pressing the trigger button . When pressing the trigger button to conduct a measurement, a light impulse is released.

The equipment has been tested in accordance with the safety requirements for electrical equipment for measurement, control, and laboratory use (IEC 61010-1:2010) and the Low Voltage Directive 2014/35/EU.

To ensure photobiological safety for the user coatmaster® Flex (SpectralBlue® model) was thoroughly tested. The operation by the end-user is classified as safe according to IEC 62471:2006.

5.5. Compatibility with flame detectors

The coatmaster® Flex has been tested and is compatible in operation with the flame detectors listed below.

Manufacturer	Flame Detector Type
STS	FL 7-64, 8-64 and 9-64. Note: must be set to UV+IR mode!
Minimax	FMX 5000 UV, FMX 5000IR, YMX 5000 IR. Conditionally compatible: YMX 5000 FMX EX 90° IR (for distances > 1m)
Total Walther	UV-03

Table 5: Flame detectors compatible with Flex

Before operating the coatmaster® Flex in any environment, check if the measurement area is under surveillance of flame detectors. If the flame detector is not listed in the above table, use the Flex in that area after receiving written confirmation either from coatmaster AG or from the supplier of the flame detector only.



6. Delivery Scope

The coatmaster® Flex is delivered with the following components in a robust transport case (scope of delivery can vary):



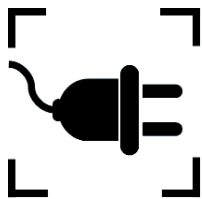
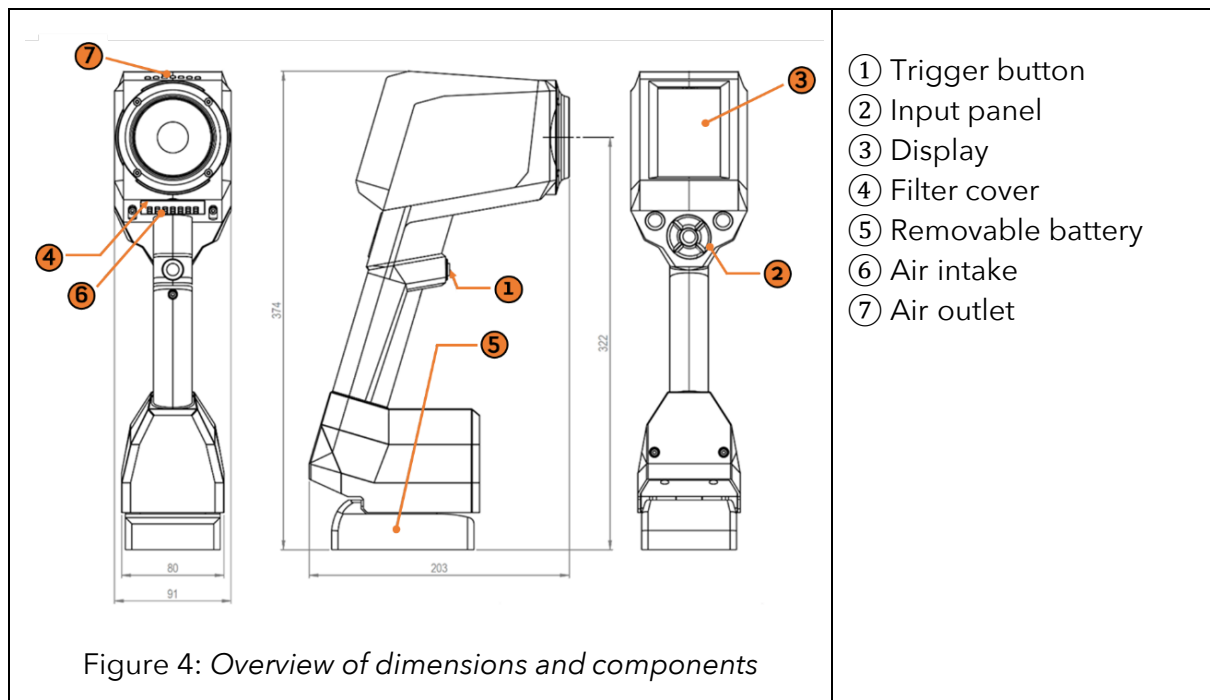

7. Set-Up

To use your coatmaster® Flex, you must set it up to connect to a Flex server by Wi-Fi connection. The Flex server can either be a coatmaster® Cloud server (through internet connection) or a coatmaster® Local server (no Internet required). To connect to the coatmaster Cloud server, a connection to the Internet is necessary.

Prior to the first usage of the Flex, the device must be activated using a 6-character license code and a 6-character activation key. License and key are provided by your Flex purchasing point. For the local Server, an additional license and key are available.

Depending on the type of server, different steps are required to activate your coatmaster® Flex:

A. coatmaster® Cloud server

To connect your Flex to the coatmaster® Cloud server, you need to have a Wi-Fi network which provides internet access. This can be your company Wi-Fi network, or any mobile Wi-Fi network provided by routers, laptops or mobile phones (hotspots). The following steps must be carried out:

1. Select Wi-Fi network and enter network credentials ([see section 7.5.](#))
2. Select appropriate cloud server ([see section 7.6.](#))
3. Enter license code and activation key received from your Flex purchasing point ([see section 7.6.](#))

Symbol	Description
	The Flex supports both WPA2 and WPA2-Enterprise secured Wi-Fi connection.

B. coatmaster® Local server

To connect your Flex to the coatmaster® Local server, you need to have a local Server device located within reach of your Flex. The following steps should be carried out:

1. Select Wi-Fi network “flex-local” ([see section 7.7.](#))
2. Select local server ([see section 7.7.](#))
3. Enter local server license and key ([see section 7.7.](#))

If you are using a local Wi-Fi network, the following steps should be carried out:



See sections **7.4**

7.5

7.6

7.1. Battery

7.1.1. Battery Charging

First charge the 18V battery pack by sliding the battery pack into the battery charger (see Figure 5: *Battery inserted in charger*). Use only the approved power charger.

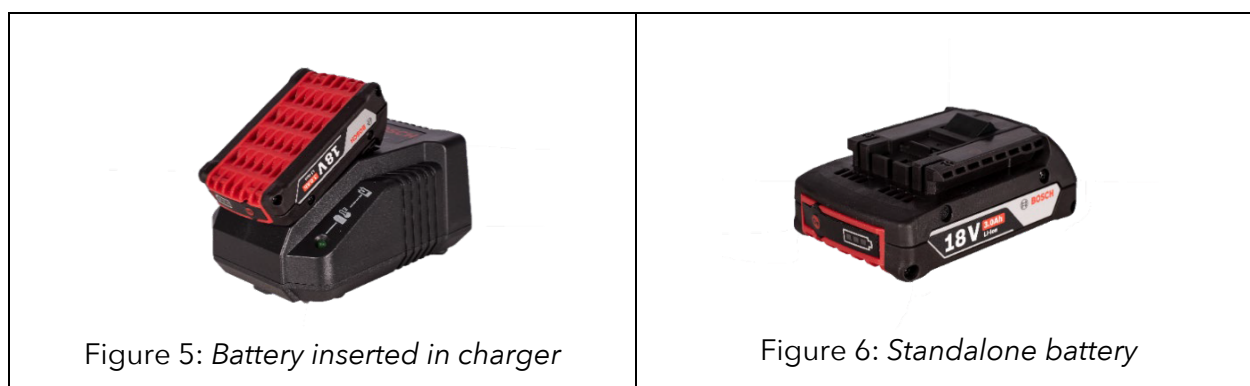

After battery charging, double-check the status of the battery by pressing the ‘On’ button of the battery pack. If the battery is fully charged, all 3 LEDs should be green (see Figure 5: *Battery charging*).



If the battery becomes defective, liquid can escape. Avoid contact. If contact accidentally occurs, flush with water. If liquid also comes into contact with the eyes, seek medical help. Liquid ejected from the battery may cause irritation or burns.

If the battery becomes defective, escaping liquid may come into contact with adjacent components. Check any affected parts. Clean such parts or replace them, if required.

7.1.2. Battery Installation

Push the fully charged battery into the designated holder at the bottom of the device until it snaps into place.

i Ensure that the red tab is completely engaged.



Figure 7: Battery installation

7.2. Navigation Panel

Figure 8: *Input panel - keys and elements* show an overview of the most important elements for navigating the menus.

	<ul style="list-style-type: none"> Ⓐ On/Off button Ⓑ Back button (to go back to the previous display or, in the menu, one level up) Ⓒ OK button Ⓓ Arrow keys
--	--

Figure 8: *Input - panel keys and elements*

7.3. Turning the Power On/Off

i After you have connected to the Flex server, and the charged battery is inserted, turn on the unit by pressing the On/Off button Ⓐ in the input panel (see Figure 8: *Input panel - keys and elements*).

It takes about 20 seconds for the coatmaster® Flex to boot up. To see the time until the coatmaster® Flex is fully operational, view the boot window on the coatmaster® Flex screen; the boot indicator scale is shown in the display.

	<p>To switch off the device, press the On/Off button Ⓐ, then confirm the action by pressing the OK button Ⓒ.</p>
--	--



Figure 9: *Turning off*

CAUTION Do not remove the battery to turn off the device!

i The device can be forced to shut down when the On/Off button is pressed for more than five seconds. With this shortcut procedure, a 'OK button ©' confirmation is not necessary.

7.4. Language Selection

After switching on the coat**master**® Flex, you will be directed to the language selection menu.

 <p>Figure 10: Language selection</p>	<p>The default language is English.</p> <p><u>Available languages:</u> Bulgarian, Czech, German, Greek, English, Spanish, Estonian, Finnish, French, Hebrew, Indonesian, Italian, Japanese, Korean, Polish, Portuguese, Romanian, Russian, Slovenian, Serbian, Thai, Turkish, Vietnamese, Indian, Chinese</p> <p>Move the cursor to your preferred language, using the up and down arrow keys   © and the OK button © to confirm.</p> <p>You will then be taken to a 'Settings' menu.</p>
---	---

7.5. Wi-Fi Settings

To use your coat**master**® Flex, you must set it up to connect to a Flex server by Wi-Fi connection. The Flex server can either be a coat**master**® Cloud server (through internet connection) or a coat**master**® Local server (no Internet required). To connect to the coat**master**® Cloud server, a connection to the Internet is necessary. If no Internet access is possible, a coat**master**® Local server must be used.

The Wi-Fi connection setup must be conducted only once for the activation of the coat**master**® Flex (see Figure 11). The login credentials are stored on the device, and afterwards the Flex will automatically try to connect to previously stored Wi-Fi networks.

If no connection is stored, the Flex will automatically start the Wi-Fi network connection process. To connect to a new Wi-Fi network, select the "Systems Settings" icon in the main display (see Figure 26), then select "Network".

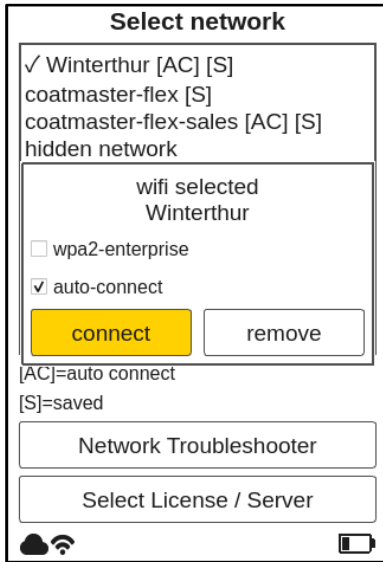

Figure 11: Wi-Fi Settings

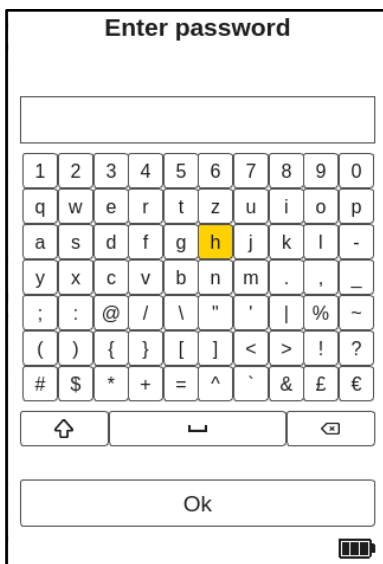
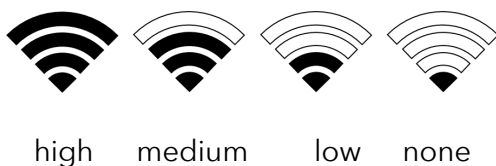

Figure 12: Password

The Wi-Fi symbol in the status line indicates the strength of the Wi-Fi signal:



When starting the coatmaster® Flex for the first time, it will automatically connect to the coatmaster® Local server, if available. If not, after language selection, the device opens the Wi-Fi network submenu so that you can select the network you wish to connect to.

Choose your local Wi-Fi network in the list using the up/down arrow keys \uparrow/\downarrow and the OK button \odot to validate.

The coatmaster® Flex supports two Wi-Fi security standards: WPA2 (only password required) and WPA2-Enterprise (username and password required).

Select the desired Wi-Fi network, using the arrow keys \odot to navigate the keyboard and press the OK button \odot to confirm the characters (see Figure 8: *Input panel - keys and elements*).

Activate the option “wpa2-enterprise” if the network requires this security level.

Activate the option “auto-connect” if you want to store the network credentials on the coatmaster® Flex for automatically connecting to this network if it is available upon boot time.

During the connection period, the following message in the status field appears:



When the Wi-Fi connection is successfully established, you must confirm using the OK button \odot .

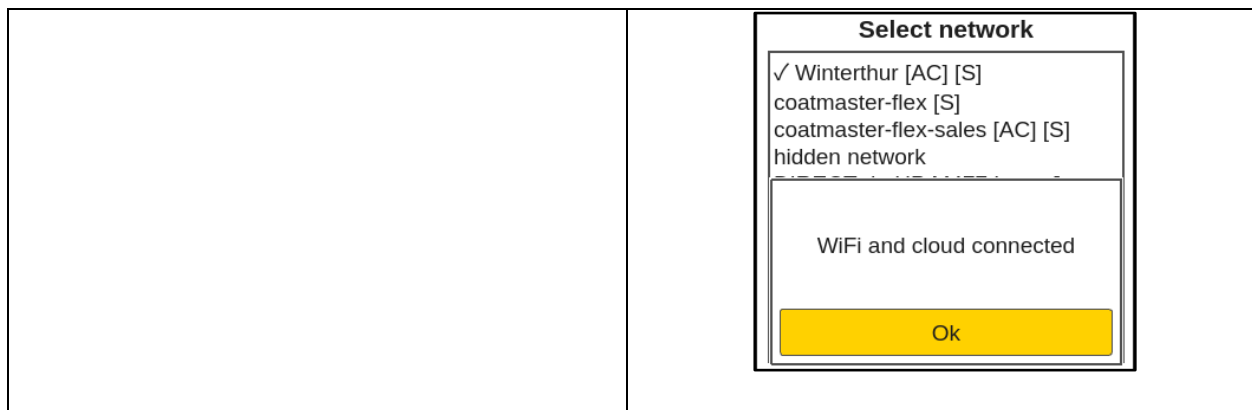

- i** If you have conducted a factory reset and need to re-activate your coatmaster® Flex, the Wi-Fi network you were connected to before, resetting will be saved and the coatmaster® Flex will automatically connect to it.
- i** Connection to the internet may be provided by mobile phone hotspots. Internet availability of course depends on mobile connection stability. Use an Android phone to connect to the coatmaster® Flex to the Internet. Usage of iOS devices may lead to connection errors.

7.6. Activation



When starting the device for the first time, or after a factory reset, with the device connected to the Internet (either with the provided local server or via the selection of a Wi-Fi network), the license code and the activation key must be entered to unlock your device. These details will have been provided separately by your purchasing point. If you are not prompted to enter the activation code and the coatmaster® Flex is working, we have already activated the device for you and no further action is required.



Before entering the license code and activation key, make sure to select the correct server from the drop-down menu as follows:

Location	Server to select
Europe	Europe
Americas	US
China	China
Asia (excl. China)	Europe
Local server	Local server License: hkeqex Key: oxjzbe
Custom servers	Custom, enter the IP address.



Figure 13: Activating menu - select server

If you are prompted to enter the activation key, the cursor moves to the License code field. When the OK button  is pressed, a submenu with a keyboard opens. Here the code can be entered, using the arrow keys  to navigate the keyboard in conjunction with the OK button  (see Figure 8: *Input panel - keys and elements*) to validate a character and move to the next one.

To save the license code, use the arrow keys  to move the cursor down to the 'Enter' field, then press the OK button . You can interrupt the operation at any time by moving the cursor to the 'Cancel' key and confirming with the OK button .

After saving the license code, the submenu for the activation key will be opened.

Proceed in a similar way to enter and save the activation key.

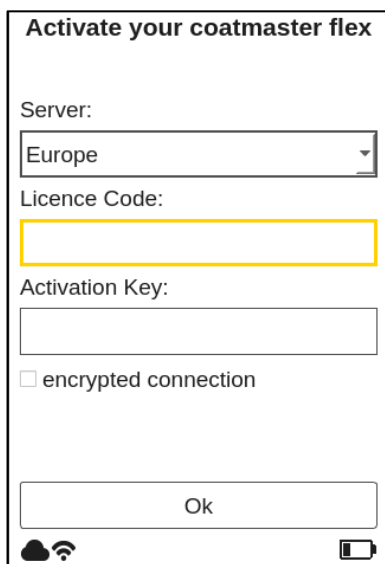

Figure 14: *Enter license code*

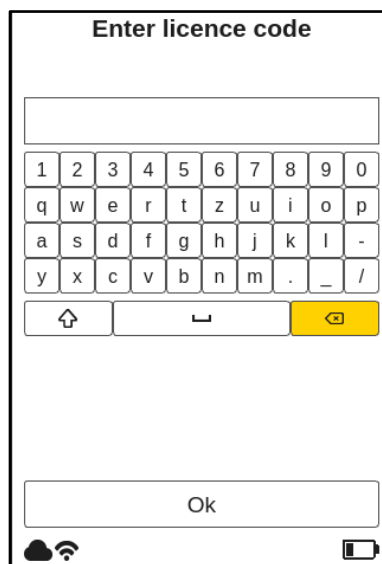

Figure 15: *Licence code*

After the activation key is saved, you will be automatically redirected to the main menu (see Figure 26: *Main display*).

Your coatmaster® Flex is now registered with the Flex server. Before you can start measuring, you need to select the appropriate user level and the units in which you want to measure (metric or imperial) ([see section 8.1.4](#)).

7.7. Operation with coatmaster® Local server

The coatmaster® Local server may be used in cases where no Internet access is available. It provides a solution for operating the Flex in a local environment, using a small computer (the local server) which provides its own Wi-Fi network.

Scope of delivery:

- Local server computer (no keyboard, no mouse, no display)
- External power supply
- 2 x Wi-Fi antenna
- 230V power cord

The local server computer is pre-configured and runs the coatmaster® server software; no additional software may be installed on this computer. Simply press the power button to start the local server.

It opens a Wi-Fi network called "flex-local", which requires no password to connect. Select this Wi-Fi from your network setting on the coatmaster® Flex.

The license code is **hkeqex**, the activation key is **oxjzbe**.

8. Operating Instructions



The following steps guide you step-by-step through the individual processes and menus. For the navigation in the following sections, the arrow keys and buttons of the input panel are used according to [section 7.2](#). (Figure 8: *Input panel - keys and elements*).

8.1. System Settings

In the main menu, select the system settings icon in the top right corner by using the left or right arrow key $\leftarrow \rightarrow$ and the OK button \odot to select and open the system settings menu.

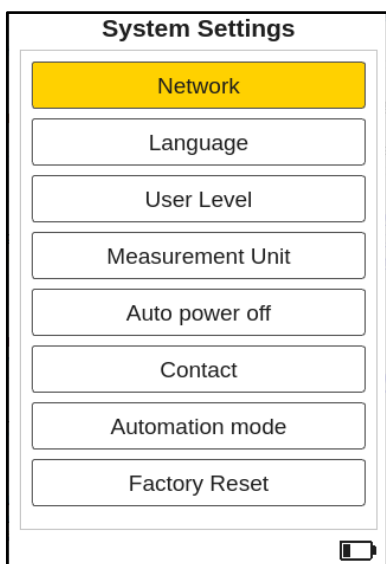

Figure 16: System settings menu

System settings contain the following categories:

- **Network**
To select and connect to a local Wi-Fi network ([see section 7.5](#)).
- **Network Troubleshooter**
(Sub menu of **Network**) To perform a network diagnosis and obtain information on the Wi-Fi status ([see section 8.1.1](#)).
- **Language**
To change the language ([see section 7.4](#)).
- **User Level**
To differentiate between the operational functionalities in the Standard or Advanced modes ([see section 8.1.3](#)).
- **Measurement Unit**
To configure and display measurement results in micrometres (μm) or in mils ([see section 8.1.4](#)).
- **Auto power off**
To change the time setting when the Flex should turn off automatically ([see section 8.1.5](#)).
- **Contact**
To display the contact information as well as the software version of the UI and the system.
- **Automation mode**
To start and stop the automation mode ([see section 8.1.8](#)).
- **Factory Reset**
To return the system to the factory settings ([see section 8.1.7](#)).

Choose the desired menu in the list, using the up/down arrow keys $\uparrow \downarrow$ and the OK button \odot to validate.

8.1.1. Network Troubleshooter

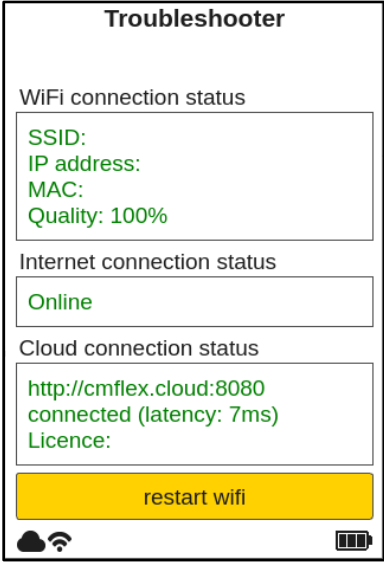
 <p>Figure 17: Troubleshooter</p>	<p>Troubleshooter</p> <p>By using the up/down arrow keys \uparrow/\downarrow and the OK button \odot in the Network menu. When activated, the system performs a network diagnosis.</p> <p>After a few seconds, the result of the network diagnosis will be shown in a report (see Figure 17: <i>Troubleshooter</i>).</p> <p>To restart the Wi-Fi connection, push the OK button \odot.</p> <p>Colour coding:</p> <ul style="list-style-type: none"> • Green - functionality correct • Red - functionality not correct <p>Use the back button $\textcircled{\leftarrow}$ to return to the main menu or to move one menu level up.</p>
---	---

8.1.2. Select license and server

- i** To change the license or the license server, the new license code can be entered, or the license server can be changed via the **Select License / Server** field. The procedure is already described in [section 8.1.2. Select license and server](#).

8.1.3. User Level

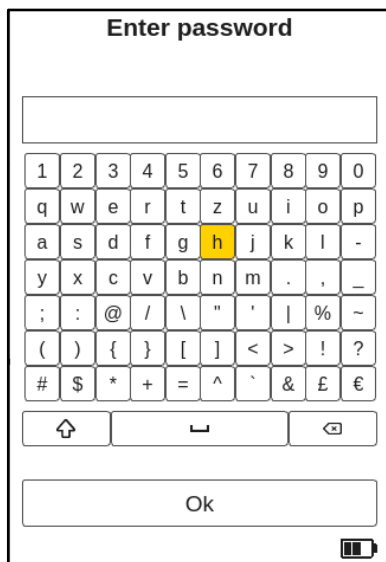

Figure 18: User level password

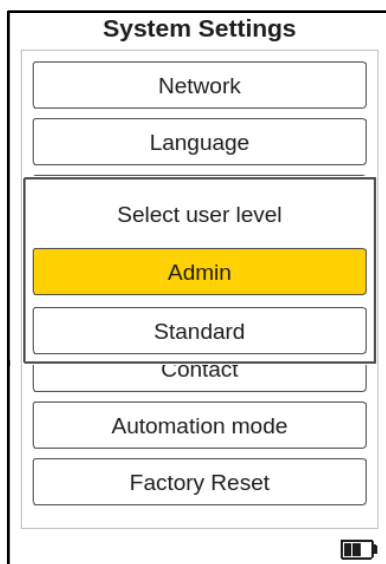

Figure 19: User level selection

The coatmaster® Flex can be operated in two different User Level modes, the attributes of which are given in Table 6: User Levels.

You can toggle between the different modes by selecting the User Level menu. When this setting option is selected for the first time, you will be directed to a keyboard window to enter your user level password. The Administrator password is **admino041**.

Enter the password, using the arrow keys Ⓒ to navigate the keyboard, in conjunction with the OK button Ⓒ (see Figure 10: *Input panel - keys and elements*) to validate a character and move to the next one.

To validate the password, move the cursor down with the arrow keys and Ⓒ into the 'Enter' field, then press the OK button Ⓒ

You can interrupt the operation at any time by moving the cursor to the 'Cancel' key and confirming with the OK button Ⓒ

After validating the user level password, you must choose the user level (Standard/Admin). The default User Level is Admin. Once you have selected a user level, the level will be saved, even if you switch off your device.

Whenever you are switching from the Standard user level to the Admin user level, you must re-enter the password as described above.

After the user level selection, you will be directed back to the system settings.

User Level	Password protected	Measurement	Block Management	Application Management	Factory Reset
Standard	No	Measure	Select	Select	No
Admin	Yes Password: admino041	Measure	Add Select Rename Delete	Add Select Edit Delete Favorite Report	Yes

Table 6: User level privileges

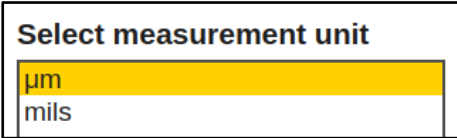

8.1.4. Measurement Unit

 <p>Figure 20: Measurement unit</p>	<p>To configure the displayed measurement units in micrometers (µm) or in mils, choose the desired unit using the up/down arrow keys \uparrow/\downarrow and the OK button \odot to validate the selection.</p>
--	---



8.1.5. Auto power off

 <p>Figure 21: auto power off</p>	<p>To change the time setting when the Flex should turn off automatically, use the up/down arrow keys \uparrow/\downarrow to select the appropriate setting and the OK button \odot to validate the selection.</p>
--	--

8.1.6. Contact information

<div data-bbox="256 247 641 815" style="border: 1px solid black; padding: 10px;"> <p style="text-align: center;">Contact</p> <p>coatmaster flex ui version: 6.3.3 system version: 1.10</p> <p>coatmaster AG Flugplatzstrasse 5 CH-8404 Winterthur +41 52 212 02 77 info@coatmaster.com</p>  <p style="text-align: center;">manual</p> <p style="text-align: right;">6.3.3 </p> </div> <p data-bbox="243 821 657 860">Figure 22: Contact information</p>	<p>The contact information provides helpful information about the installed UI version as well as the system version number of the coatmaster® Flex.</p> <p>This information is important for coatmaster AG service technicians to eventually support and find solutions to any problems regarding the measuring device.</p> <p>Furthermore, the contact details of coatmaster AG are listed here.</p> <p>It is also possible to access the current operating instructions of the Flex as a link by means of a QR code. For example, the QR reader of a smartphone or tablet can be used for this purpose.</p>
---	--

8.1.7. Factory Reset

<div data-bbox="224 1102 673 1343" style="border: 1px solid gray; padding: 10px;"> <p style="text-align: center;">Are you sure you want to reset and reboot?</p> <div style="text-align: center; margin-top: 10px;"> <div style="background-color: yellow; padding: 5px 20px; display: inline-block;">Reset</div> </div> </div> <p data-bbox="284 1343 609 1382">Figure 23: Factory reset</p>	<p>Allows you to reset the system to the factory settings.</p> <p>The factory reset will also reset the activation and will reboot the device!</p> <p>Select the 'Reset' field, using the left/right arrow keys   and the OK button  to reset the device to the factory settings and deactivate the license. Alternatively, select the 'Cancel' field to return to the system settings menu.</p>
---	--

 Only users using the Flex in Admin mode can do a Factory reset. For the Standard User Level this option is greyed out and cannot be activated.

8.1.8. Automation mode

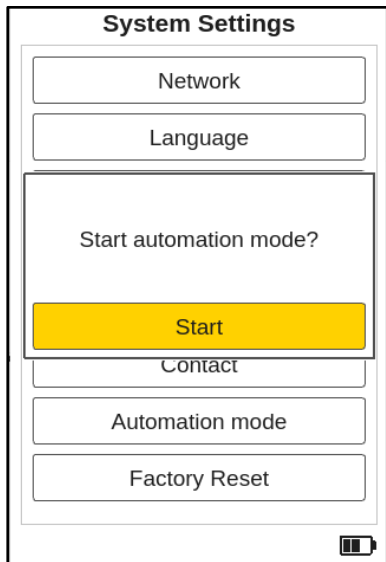

Figure 24: auto power off

To start the automation mode, use in the settings menu the up/down arrow keys \uparrow/\downarrow \odot to select and push the OK button \odot to start.

In this state, the Flex can receive and process commands from a PLC system and enable system control. Applications and blocks can no longer be selected.

These are now specified by the PLC.

A message in the Flex display indicates that the automation mode is running.

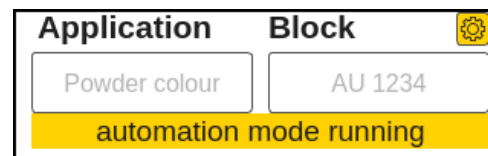

To stop the automation mode repeat the procedure, by using the up/down arrow keys \uparrow/\downarrow \odot in the settings menu to select and push the OK button \odot to stop.

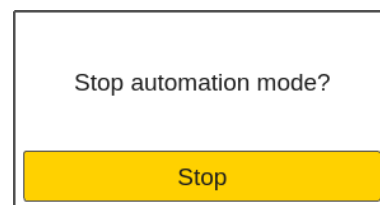
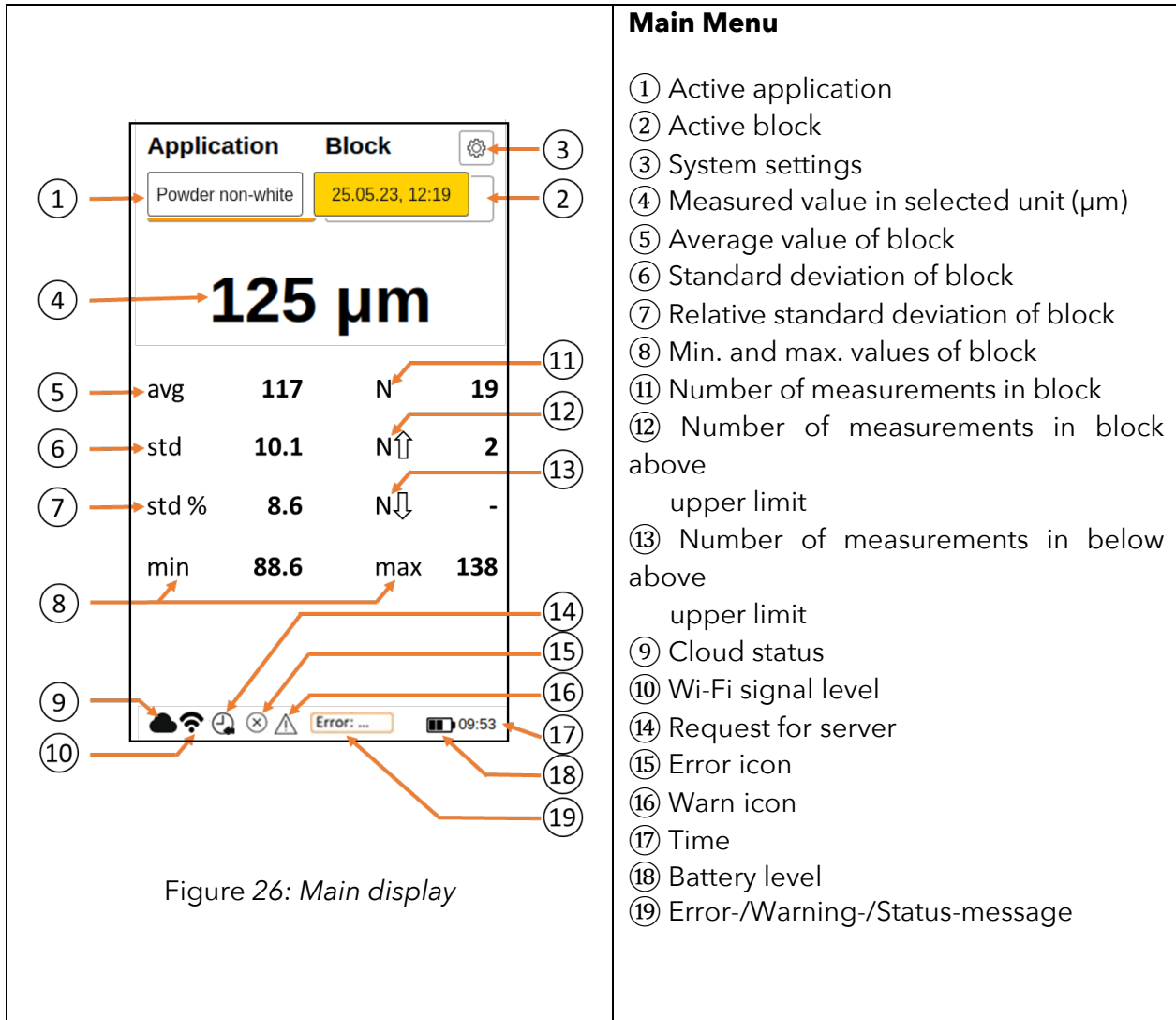

Figure 25: Stop automation mode

8.2. Main Menu

The main menu, and descriptions of the elements of the coatmaster® Flex, are shown in Figure 26: Main display.



The following options are available in the main menu:

a. Access to the application menu

Use the left or right arrow key \leftarrow \rightarrow and the OK button \odot to select the application.

b. Access to the block menu

Use the left or right arrow key \leftarrow \rightarrow and the OK button \odot to select the block.

c. Triggering a measurement

Press the Trigger button $\textcircled{1}$ (see Figure 4: *Overview dimensions and components*) to start a measurement.

d. Display last twelve measurements

Use the up-arrow key \uparrow to display the last twelve measured values numerically in the display. Use the down arrow key \downarrow to return to the main menu.

e. Display trend chart

Use the down arrow key \downarrow to display graphically the measured values in the trend chart. Use the up-arrow key \uparrow to return to the main menu.

f. System settings

Use the left or right arrow key \leftarrow \rightarrow and the OK button \odot to select system settings (see 8.1 System Settings).

Use the back button $\textcircled{\leftarrow}$ to return to the main menu or to move one menu level up.

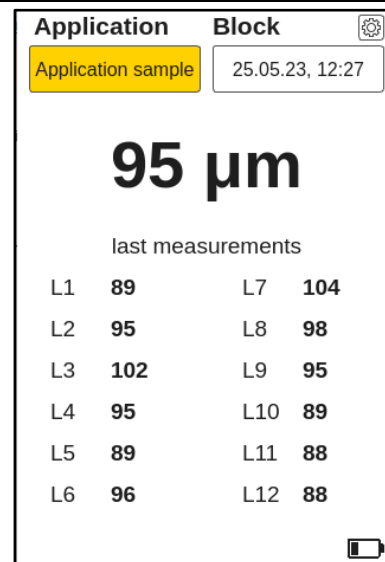

Figure 27: Display last twelve measurements

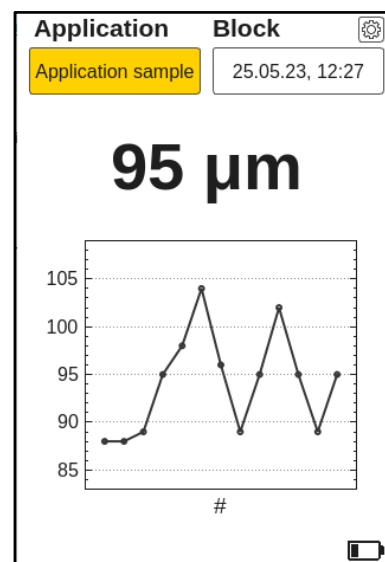

Figure 28: Display trend chart

8.3. Block Menu

In the main menu use the left or right arrow key \leftarrow \rightarrow to select the 'Block' field and confirm with the OK button \odot according to [section 7.2](#). (Figure 8: *Input panel - keys and elements*).



The Block menu is accessible by all user levels, but with limited privileges for the Standard user level ([see section 8.1.2](#)).

8.3.1. Select a block

Block saves different measurement series in separate directories. The statistics of the selected block are displayed in the main menu and in the trend chart.

To use a block, select a block from the list and choose 'select'.

You can select the desired block by using the up/down arrow keys \uparrow \downarrow \odot and the OK button \odot from the input panel.

If you choose a block within the list of available blocks the color will change to light orange.

To activate one of the three icons ('select', 'rename' or 'remove') use in the block menu the left or right arrow key \leftarrow \rightarrow \odot and the OK button \odot from the input panel.

To abort and return to the block menu, use the back button \odot .

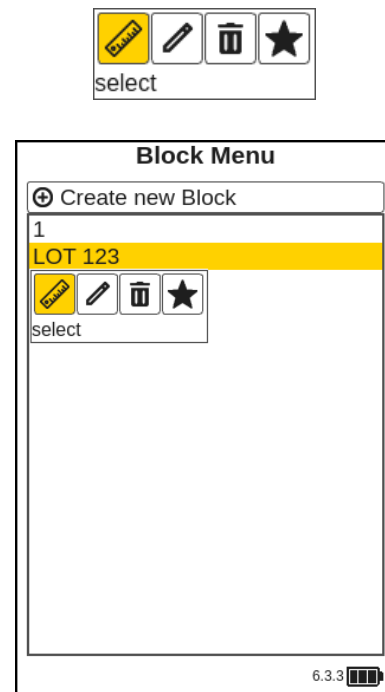

Figure 29: Select block

8.3.2. Create a new block

If you choose 'Create new Block' in the block menu, a new block with the current selected date and time or a consecutive number, depending on the setting in the WEB UI, will appear in the list.

The current display switches directly back to the main display and the newly created block is immediately active and displayed with the block name in the block field.

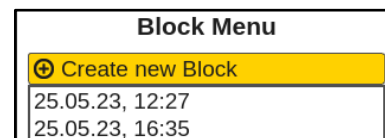

Figure 30: Create new Block

8.3.3. Rename a block

To edit a block, select a block from the list and choose 'rename'.

If you choose a block within the list of available blocks the color will change to light orange. You can select the desired block by using the up/down arrow keys \uparrow \downarrow \odot and the OK button \odot from the input panel.

To 'rename' the desired block, use in the block menu the left or right arrow key \leftarrow \rightarrow \odot and the OK button \odot from the input panel. Select the 'rename' icon. You must confirm with 'OK'.

In the submenu you can rename the block by navigating the keyboard using the arrow keys \odot and entering the characters using the OK button \odot from the input panel. Select 'OK' to confirm the new block name.

To abort and return to the block menu, use the back button \odot .



Figure 31: Rename block

8.3.4. Remove a block

To delete a block, select a block from the list and choose 'remove'.

If you choose a block within the list of available blocks the color will change to light orange. You can select the desired block by using the up/down arrow keys \uparrow \downarrow \odot and the OK button \odot from the input panel.

To 'remove' the desired block, use in the block menu the left or right arrow key \leftarrow \rightarrow \odot and the OK button \odot from the input panel.

Select the 'remove' icon and confirm with 'OK'.

To abort and return to the block menu, use the back button \odot .

Standard users cannot 'remove' blocks! This option is then greyed out and cannot be selected!

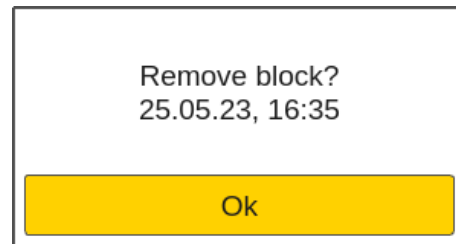

Figure 32: Remove block

8.3.5. Favorite a block

You can set favorites within the blocklist. These are highlighted in yellow when enabled.

Favorite blocks are placed at the top of the blocklist.

If you select a block from the list of available blocks, the color will change to light orange. You can select the desired block using the up/down arrow keys \uparrow \downarrow (D) and the OK key (C) from the input field.

To enable or disable the "Favorite" icon, use the left or right arrow key \leftarrow \rightarrow (D) and the OK key (C) from the input field in the application menu.

To mark the desired block as a "favorite", confirm with the OK key (C) from the input field.

To cancel and return to the application menu, use the Back button (B).

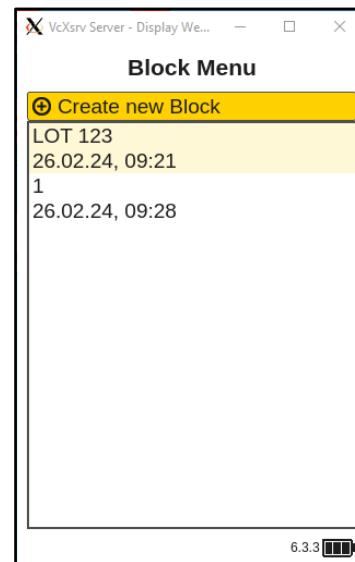
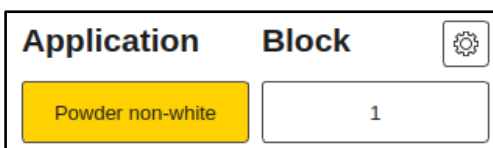

Figure 33: Favorite block

8.4. Application Menu



and elements).

In the main menu, use the left and right arrow keys \leftarrow \rightarrow \odot to select the 'Application' field, and confirm with the OK button \odot , according to [section 7.2](#). (Figure 8: Input panel -keys

Standard users are only able to 'Select' applications! Other options are *greyed out* and cannot be chosen! Admin users have access to all options (see 8.1.2 User Level).

In the application menu, specific measurement parameters can be set. By using applications, these measurement parameters can be applied across a consistent set of measurements. In the original state of the coatmaster® Flex, you will find five pre-set applications. They are displayed in **bold**.



- **Powder white** is a pre-set application for measuring white uncured powder.
- **Powder non-white** is a pre-set application for measuring uncured powder with any color except white.
- **Cured white** is a pre-set application for measuring cured white coating.
- **Cured non-white** is a pre-set application for measuring cured coating of any color except white.
- **Calibration standard** is a pre-set application for checking the calibration of your device with certified plates.



If you choose an application within the list of available applications, the color will change to light orange. You can select the desired application by using the up/down arrow keys \uparrow \downarrow and the OK button \odot from the input panel. Confirm the selection by pressing the OK button \odot from the input panel again.

Flash discharge: When changing from a white application to a non-white one, or vice versa, the flash generator in the coatmaster® Flex must discharge. A warning message is displayed and, when confirmed with 'Ok', a flash is immediately triggered.

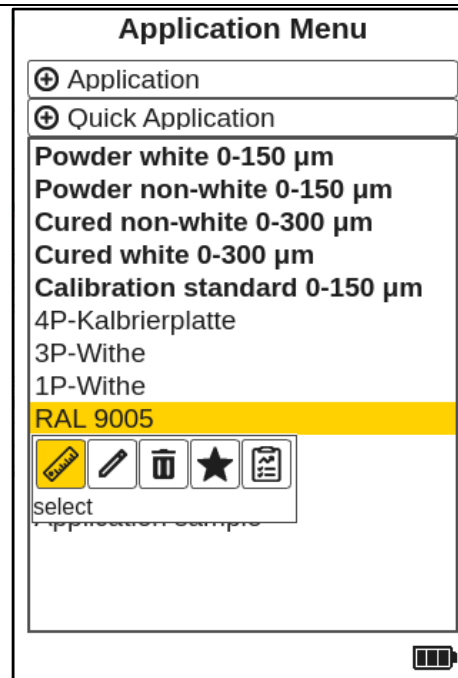

Figure 34: Application menu

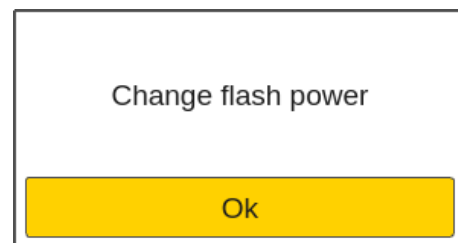

Figure 35: Flash energy change



Greyed out applications written in italics cannot be selected and require further input, for which Admin level privileges are required. To complete such an application, it is necessary to perform at least one reference measurement with the corresponding layer thickness, as explained in the following section.

8.4.1. Delete an application

To remove an application, select an application from the list and choose 'delete'.

If you choose an application within the list of available applications, the color will change to light orange. You can select the desired application by using the up/down arrow keys \uparrow \downarrow \odot and the OK button \odot from the input panel.

To activate the 'delete' icon, use in the application menu the left or right arrow key \leftarrow \rightarrow \odot and the OK button \odot from the input panel.

To 'delete' the desired application, you must confirm with 'OK'.

To abort and return to the application menu, use the back button \ominus .

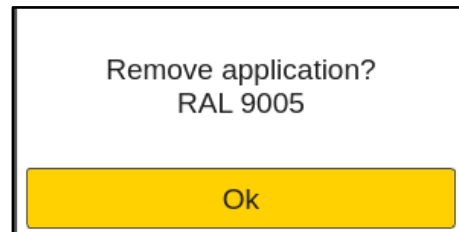

Figure 36: Remove an application



Pre-set applications written in bold letters can be neither removed nor edited, even in the Admin mode.

8.4.2. Favorite an application

You can set favorites within the application list.

These are highlighted in yellow when activated.

Favorite applications are placed at the top of the application list.

If you choose an application within the list of available applications, the color will change to light orange. You can select the desired application by using the up/down arrow keys \uparrow \downarrow \odot and the OK button \odot from the input panel.

To activate or deactivate the 'favorite' icon, use in the application menu the left or right arrow key \leftarrow \rightarrow \odot and the OK button \odot from the input panel.

To 'favorite' the desired application confirm with the OK button \odot from the input panel.

To abort and return to the application menu, use the back button \oplus .

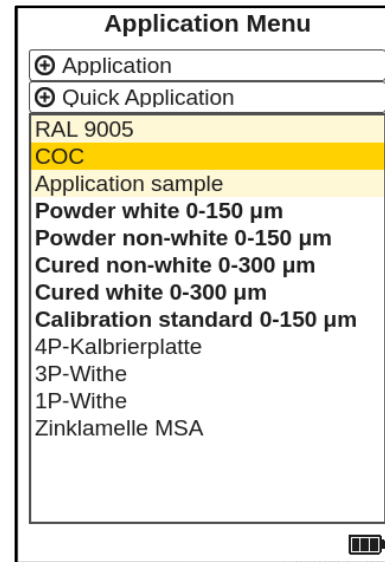



Figure 37: Favorite applications



8.4.3. Advanced calibration report



A summary of the calibration parameters is displayed in the advanced calibration report. If all parameters are green, the calibration is successful.

 For more Information see [section 8.4.4.4.](#)

The default report only shows a check mark next to the label in green for ok or red for not ok.

No graph will be displayed.

If you choose an application within the list of available applications, the color will change to light orange. You can select the desired application by using the up/down arrow keys   and the OK button  from the input panel.

To activate the 'report' icon use in the application menu the left or right arrow key   and the OK button  from the input panel.

To abort and return to the application menu, use the back button  or confirm with 'OK'.

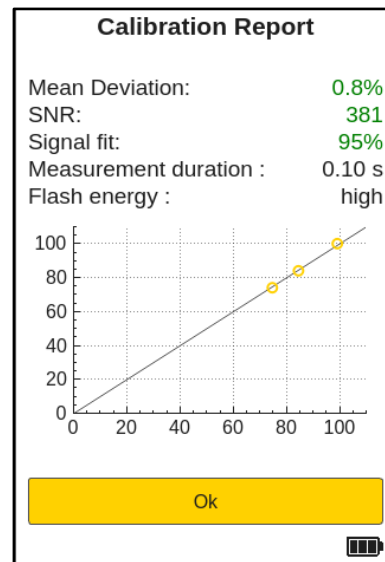

Figure 38: Advanced report

8.4.4. Calibration Menu

If the existing factory applications are not suitable for your use, you can edit an existing, or add a new, application (only in the Admin user mode).

There are two ways to create a new application and thus a new calibration: Selecting 'edit' or '⊕ Application' (see [section 8.4.4.2.](#)) or '⊕ Quick Application' (see [section 8.4.4.1.](#)) in the application menu will direct you to the calibration menu.

8.4.5. Quick Application

When you select '⊕ Quick Application', the Reference Measurements display will appear (see Figure 38: *Reference Measurements*).

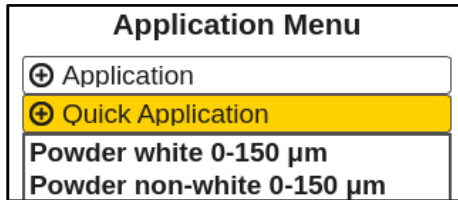

Follow the instruction on the display.

For next steps see [section 8.4.4.3](#). Reference Measurements.

To abort and return to the application menu, use the back button ⊖.

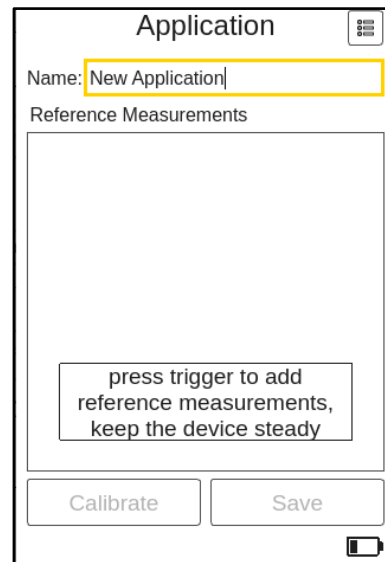
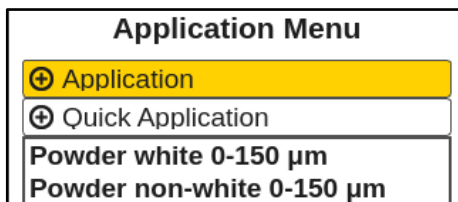

Figure 39: Reference Measurements

8.4.6. Manual Application

When you select '⊕ Application', a new display will appear (see Figure 39: *Material Properties*), which displays the calibration options that were initially chosen.



Use the up/down arrow keys ⬆ ⬇ to navigate between the different fields and press the OK button ⊙ to open the corresponding drop-down menu. To select an option in the drop-down menu, proceed in the same way.

The 'Materials properties' menu offers the following options:

- **Coating**
Cured, Powder uncured, Wet uncured
- **Substrate**

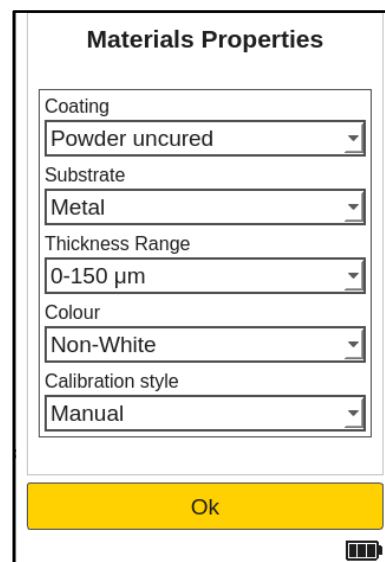

Figure 40: Material Properties

<p>Metal, Non-Metal</p> <ul style="list-style-type: none"> • Thickness range 0-20 µm; 0-50 µm; 0-150 µm; 0-300 µm; 0-1,000 µm • Colour White, Non-white (any colour except white) • Calibration Style Manual, Automatic <p>To continue confirm with 'OK'.</p> <p>When you confirm the Materials Properties menu with 'OK' the Reference Measurement display will appear (see Figure 40: <i>Reference Measurements</i>).</p> <p>Follow the instruction on the display.</p> <p>For next steps see section 8.4.4.3. Reference Measurement.</p> <p>To abort and return to the application menu, use the back button Ⓢ.</p>	 <p>The screenshot shows a mobile application interface titled 'Application'. At the top right is a menu icon. Below the title, there is a 'Name:' field containing 'New Application '. Underneath is the heading 'Reference Measurements' followed by a large empty rectangular box. A text box in the center of this area contains the instruction: 'press trigger to add reference measurements, keep the device steady'. At the bottom of the screen are two buttons: 'Calibrate' and 'Save'. A battery icon is visible in the bottom right corner.</p>
--	---

Figure 41: Reference Measurements

8.4.7. Reference Measurements

Now you can proceed to conduct a reference measurement to calibrate your device for this new application.

At this point, position your coatmaster® Flex approximately **5 cm** away from the reference sample and press the trigger button ① (see Figure 41: *Reference / calibration measurement*).

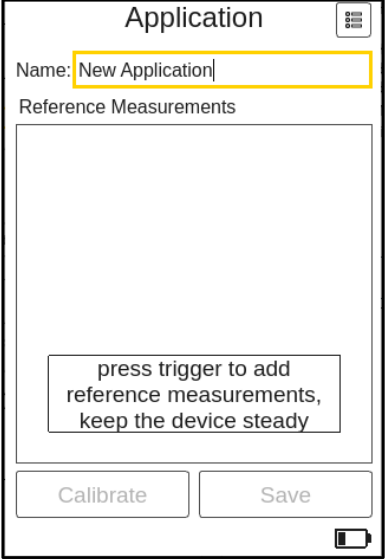
A reference measurement will be taken, and this reference measurement will be displayed, with a calculated thickness value (100 µm), in the reference list (see Figure 42: *References*).

To take an additional reference measurement repeat the process.

A maximum of 5 reference measurements can be created. If more than 3 reference measurements are available, the algorithm automatically generates an off-set ([see section 8.4.6.](#)).



Figure 42: *Reference/calibration measurement*

To adjust or edit the reference measurement value, use the arrow keys Ⓢ and adjust the measuring value to a known thickness and use the OK button Ⓢ from the input panel.

Using the up/down arrow keys Ⓢ Ⓢ Ⓢ will in- or decrease the number and the left or right arrow key Ⓢ Ⓢ Ⓢ will switch to the next numerical unit. You must confirm with the OK button Ⓢ from the input panel.

Alternatively, you can 'Save' the application and edit the reference name and thickness at a later stage.

To abort and return to the application menu, use the back button Ⓢ.

If you choose a reference measurement within the list of available reference measurements, a light orange frame will appear around the selected reference measurement. You can select the desired reference measurement by using the up/down arrow keys Ⓢ Ⓢ Ⓢ and the OK button Ⓢ from the input panel.

To delete a reference measurement, use the left or right arrow key Ⓢ Ⓢ Ⓢ and select the garbage can icon and OK button Ⓢ from the input panel.

To delete the desired reference measurement, you must confirm with 'OK'.

To abort and return to the application menu, use the back button Ⓢ.

Measurements without a reference value are ignored in the calibration evaluation. Once all settings for the new application are established, navigate with the arrow keys Ⓢ to the 'Calibrate' field ③ (see Figure 42: *References*).

- ① Application name
- ② Reference/calibration measurement(s)
- ③ 'Calibrate' (which starts the calibration process at the server).

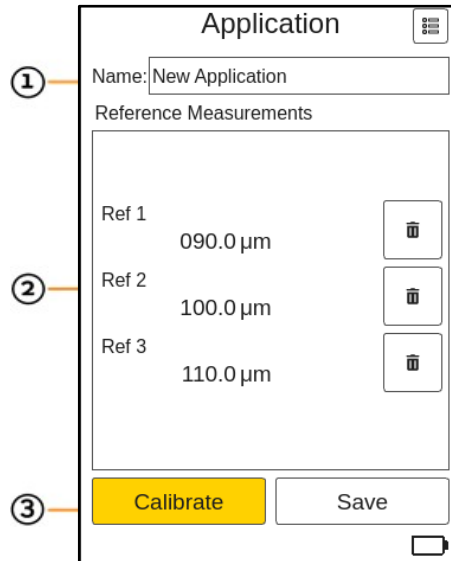

Figure 43: *References*



In order to make more accurate measurements with a single application, you are advised to make at least two reference measurements with two different layer thicknesses with the coatmaster® Flex. Trigger a reference measurement in the calibration menu by pressing the trigger button Ⓢ again.



Please be careful to enter the reference value in the units that were selected in the Settings Menu Measurement Unit ([see section 8.1.4.](#)).

A calibration report as shown in Figure 43: *Basic Calibration Report* will be generated by the coatmaster® Flex software.

 The software will automatically check the results and will clearly display the status of the calibration process.

Select 'Ok' to return to the main menu.

To get a more detailed information about the calibration select 'Advanced report' (see Figure 44: *Advanced Calibration Report*).

A summary of the calibration parameters is displayed in the advanced calibration report. If all parameters are **green**, the calibration was successful.

The default Basic report only shows a check mark next to the label in **green** for ok or **red** for not ok.

No graph will be displayed.

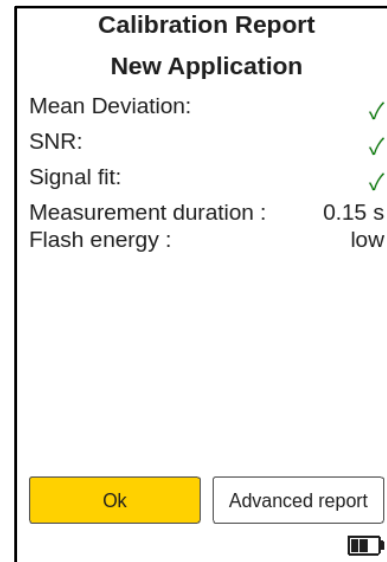

Figure 44: *Basic Calibration Report*

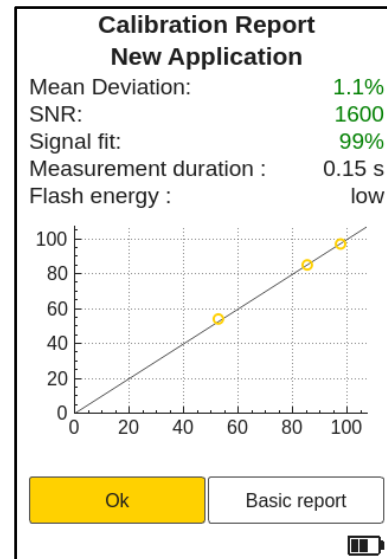

Figure 45: *Advanced Calibration Report*

8.4.8. Calibration Report

The calibration report provides an evaluation of the calibration performed. You will see the following values in the advanced report (see Figure 44: *Advanced Calibration Report*)

- **Mean Deviation** ((MD)of coatmaster® Flex from the reference value):
 - The value should be less than 10%.
 - The lower the value, the more accurate your measurement.
 - If the value is greater than 10%, check the reference value.

- **SNR** (Signal to Noise Ratio):
 - The SNR value should be greater than 100.
 - The higher the value, the less sensitive to perturbations your measurements will be.
 - If the value is less than 100, move the measuring device closer to the surface and increase the light energy, if necessary.

- **Signal Fit** (SF):
 - The signal fit value should be greater than 90%.
 - If the value is less than 90%, clean the optics with clean, dry, lint-free paper cloths and repeat the calibration procedure.
 - If the signal adjustment is still below 90%, please contact our Technical Support hotline (contact details on page 2).

- **Measurement duration:**
 - Depending on the to be measured coating thickness.
 - When changing in the Materials Properties (see Figure 43: *Material Properties*) the Thickness Range regarding the expected dry film coating thickness the duration of the measuring time will be calculated.
 - The higher the Thickness Range Is the higher will be the Measurement duration.

- **Flash energy:**
 - Depending on the to be measured color of the coating material.
 - When changing in the Materials Properties (see Figure 43: *Material Properties*) the Colour regarding the applied color of the coating material the Flash energy will be adjusted.
 - White uses a high Flash energy and Non-White uses a low Flash energy.

The above values will be calculated and checked automatically by the coatmaster® Flex software after 'Calibrate' has been activated in the calibration menu.

8.4.9. Rename application

To edit the Application Name select the desired application in the application menu, using the up/down arrow keys \uparrow \downarrow and the OK button \odot from the input panel. If you choose an application within the list of available applications, the color will change to light orange.

To activate the 'edit' icon, use in the application menu the left or right arrow key \leftarrow \rightarrow and the OK button \odot from the input panel.

Use the up/down arrow keys \uparrow \downarrow to activate the field for name and press the OK button \odot from the input panel.

In the submenu (see Figure 45: *Application Name*) you can rename the application name by navigating the keyboard using the arrow keys \leftarrow \rightarrow and entering the characters using the OK button \odot from the input panel.

Select 'OK' to confirm the new application name or abort your action with the back button \ominus .



Figure 46: *Application Name*

8.4.10. Edit Materials Properties or DisplayOptions

To edit the Materials Properties and the Display Options, select the desired application in the application menu by using the up/down arrow keys \uparrow \downarrow and the OK button \odot from the input panel. If you choose an application within the list of available applications, the color will change to light orange.

To activate the 'edit' icon, use in the application menu the left or right arrow key \leftarrow \rightarrow and the OK button \odot from the input panel.

Use the up/down arrow keys \uparrow \downarrow to activate the property icon at the top right corner of the display and press the OK button \odot from the input panel.

The Advanced calibration options display will appear (see Figure 47: *Advanced calibration options*).

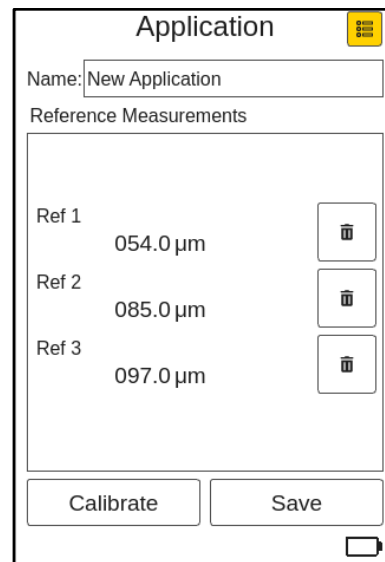

Figure 47: Property

8.4.11. Materials Properties

Use the up/down arrow keys \uparrow \downarrow to select 'Materials Properties' (see Figure 47: *Advanced calibration options*) and press the OK button \odot from the input panel.

The Materials Properties display will appear (see Figure 48: *Materials Properties*).

For next steps see [section 8.4.4.2](#). Manual Application.

To abort and return to the Advanced calibration options, use the back button \ominus .

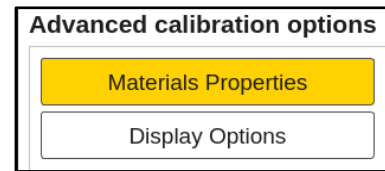

Figure 48: *Advanced calibration options*

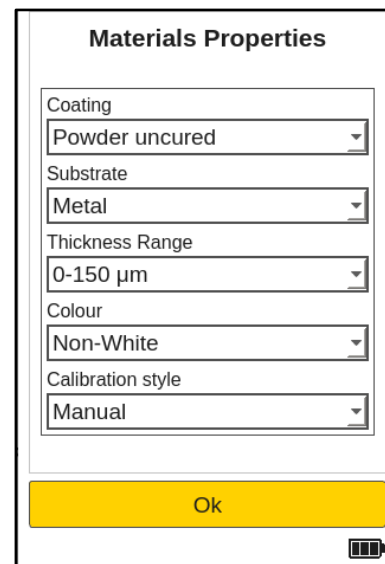

Figure 49: *Material Properties*

8.4.12. Display Options

Use the up/down arrow keys \uparrow \downarrow to select 'Display Options' (see Figure 49: *Advanced calibration options*) and press the OK button \odot from the input panel.

The Display Options display will appear (see Figure 50: *Display Options*).

For next steps see [section 8.4.4.9](#). Display Options (Bounds).

To abort and return to the Advanced calibration options, use the back button \ominus .

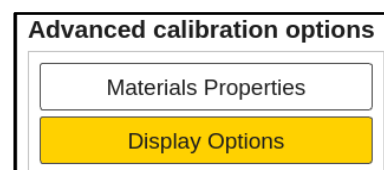

Figure 50: *Advanced calibration options*

8.4.13. Display Options (Bounds)

The display options (see Figure 50: *Display Options*) will configure your display and the bounds in the trend chart (see Figure 49: *Principle of Application Bounds*).

Bounds (limits) can be configured and optionally displayed for the:

- **Warning Bound**
Tolerance to initiate process changes
- **Error Bound**
Quality tolerance
- **Range Bound**
Display limits of the chart
- **SNR Threshold**
Minimum value to avoid faulty measurements

To enable a bound, navigate with the up/down arrow keys \uparrow \downarrow to the desired field and enable by pressing the OK button \odot . The fields with lower and upper descriptions will appear in the Display options display.



It is essential that the bounds values are chosen according to the units selected in the Settings menu Measurement Unit ([see section 8.1.4.](#)). Activate one of the bound fields by pressing the button \odot .

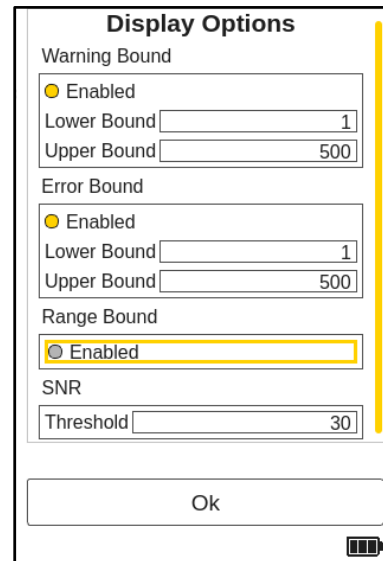

Figure 51: *Display Options*

Setting Bounds

To understand the relationship between the bounds in the trend chart, see Figure 51: *Principles of Application Bounds* and the Display Options in the Application menu (see Figure 52: *Application Bounds*).

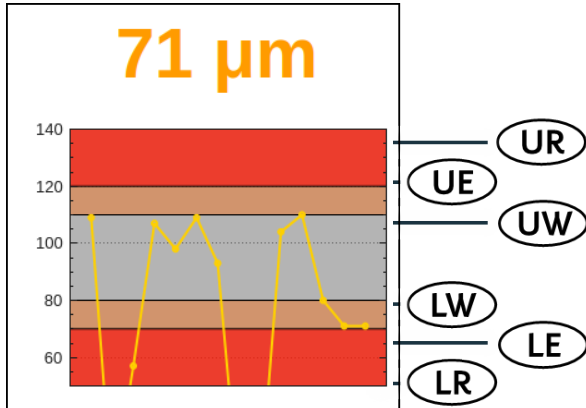

Figure 52: *Principles of Application Bounds*

- Measurement values inside the red bands of the chart are outside quality tolerance levels.
- Measurement values inside the yellow bands of the chart are in a warning zone, and corrective measures for the process must be taken.
- Measurement values inside the white bands of the chart are satisfactory. No measure is required.

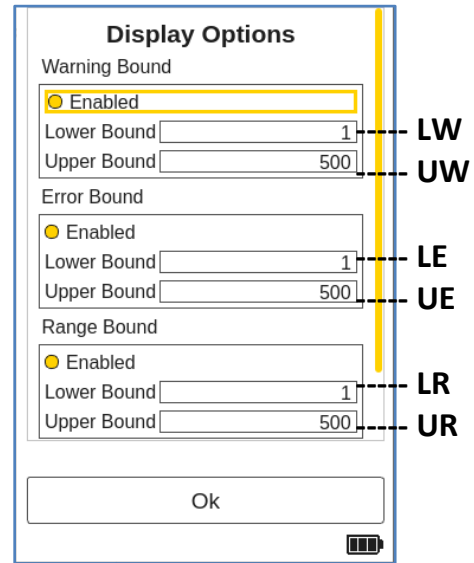

Figure 53: *Application Bounds*

- UR** = Upper Range
- UE** = Upper Error
- UW** = Upper Warning
- LW** = Lower Warning
- LE** = Lower Error
- LR** = Lower Range

If the measured values are out of range, the color of the current measurement turn to orange for a Warning (see Figure 53: *Lower Warning*).and to red for an Error (see Figure 54: *Upper Error*).

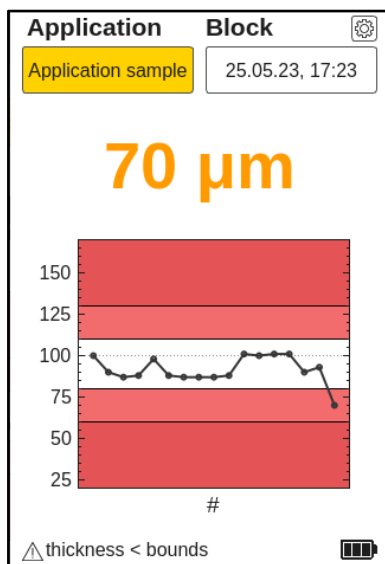

Figure 54: *Lower Warning*

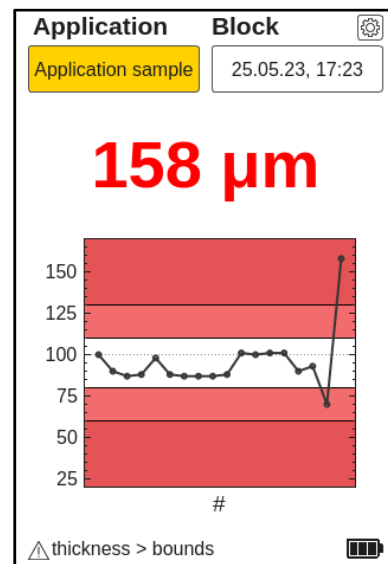

Figure 55: *Upper Error*



The coating color type determines the intensity of the flash. This means that a white sample generally requires more energy to achieve the desired temperature change on the surface. The coating color type (i.e., White or Non-White) must be chosen before a reference measurement can be made.

In the 'Upper Bound' keyboard display e.g., you can enter the value of the bounds analogously with the up/down arrow keys and the OK button . Press the 'OK' button to validate the new bound value or use the back button to return to the Advanced calibration options.

If the consistency of the bounds is not considered, or values are entered incorrectly, a red warning message will appear.

When you have established all your settings in the Display Options menu, select 'OK' to continue to the 'Calibration' display.

To abort and return to the Advanced calibration options, use the back button .

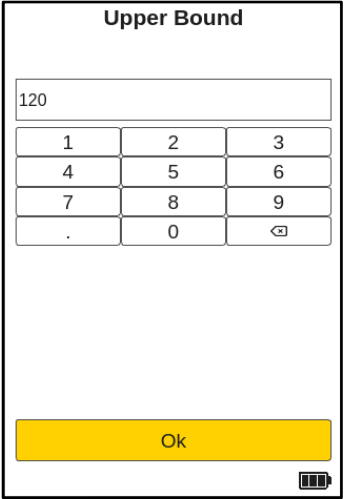



Figure 56: Bound setting

Setting the SNR Threshold

The SNR threshold value is set in a second step after the calibration procedure has been completed. To do this, the coatmaster® Flex application must be edited again after completing the calibration for the first time. The reason for this is that the nominal value for the SNR threshold is only available in the calibration report after taking the reference measurements on the coating (see [section 8.4.4.4. calibration report](#)).

The SNR value measures the amplitude of the temperature response on the surface of the coating. In this example application, the SNR value shown in the calibration report is SNR = 2090 (dimensionless). If the coatmaster® Flex is aimed at another surface if it is too far away from the coating, the SNR value for the measurement will decrease. We can set an SNR threshold to determine the minimum SNR value required of a measurement to be acceptable. As a rule of thumb, you can use half of the value shown in the calibration report (i.e., in this example, set SNR Threshold = 1045). If you want higher selectivity for measurements, increase the SNR threshold. It should not be increased over the value from the calibration report

8.4.14. Example of a Calibration Process

 For further clarification of the calibration procedure, we describe the procedure using an example of a dark powder coating (RAL9005) on aluminium:

Step 1: Prepare three samples with coatings that are as different as possible; for instance:

- a. Sample 1: 40-60 µm
- b. Sample 2: 80-100 µm
- c. Sample 3: 120-140 µm

Step 2: In the 'Application' menu, select '⊕ Application'.

Step 3: In the 'Material properties' enter the appropriate material properties ([see section 8.4.4.6.](#)).

In this case:

- d. Coating: Powder uncured
- e. Substrate: Metal
- f. Thickness range: 0-0-150µm
- g. Colour: Non-white
- h. Calibration Style: Manual

To continue confirm with 'OK'.

Step 4: Edit the name of the application into 'RAL9005' in the 'Application Name' field ([see](#)

[section 8.4.4.5.](#)). Select 'OK' to confirm the new application name.

Step 5: Make a reference measurement for each sample with a dedicated measuring point. Note which reference measurement in the coatmaster® Flex calibration menu belongs to which reference sample and dedicated measuring point. If the coatmaster® Flex is required for another purpose, the dialogue box can be closed with 'Save'. The samples may now be cured.

Step 6: In the 'Display Options' menu ([see Section 8.4.4.6.](#)), select the display options based on your quality management requirements. To continue confirm with 'Ok' and use the back button  to get back to the reference measurement menu.

Step 6: After the samples have cooled down, make a measurement with a standard contacting coating thickness gauge at the points noted in step 5.

Step 7: If the calibration menu has been closed, select 'RAL9005' in the application menu and then 'edit'. Press the OK button  from the input panel to access the reference measurement ([see section 8.4.4.6.](#)). Now the values from step 5 can be entered for the respective reference measurements and you can complete the calibration by selecting 'Calibration'.

 **A note on the number of samples required for calibration.**

Calibration with just one sample will usually be accurate in the thickness range of that sample, but accuracy may be less when measuring at thickness which deviates from the thickness of the calibration sample. If you need higher accuracy across a longer thickness range, we suggest more calibration samples (for example three samples as described above).

**A note on the thickness of the calibration samples**

Calibration samples should cover the whole measurement range. If, for example, measurements with the Flex are to be conducted up to 150 μm , then a calibration sample at 150 μm should be used to ensure maximum accuracy of the Flex measurement. If the measurement value exceeds the maximum calibration measurement by a factor of 2, the Flex will not display the measurement value because of potentially high inaccuracy.

**Quick 5-minute calibration**

A tutorial video showing a quick 5-minute calibration by using a hot air blower for curing is available on YouTube: https://youtu.be/_RTlbfQXAG4

8.4.15. Offset calibration

For some measurement applications it sometimes occurs that the Flex measurement results are accurate in one thickness range (usually, the thickness of the calibration sample), but there is a systematic deviation of the Flex measurement results at lower or higher thickness. For example, Flex thickness measurements are ok in the range of 80 μm , but we see that the Flex measures always around 10 μm too high in the range of 40 μm . Such systematic deviations can occur, for example, if an uncured coating is to be measured with the Flex on a cured coating. Another situation where such systematic differences arise is when measuring thin coatings at 10 μm or less.

If the deviation is systematic, it can be compensated with an offset calibration. To make an offset calibration with the Flex requires at least two calibration samples (in contrast to the standard application, where minimum one sample is required). In addition, the two samples must be different in coating thickness at least by a factor of two, in order to provide an accurate offset determination.

In our example, if we want to make an offset calibration to measure a coating up to 80 μm thickness, we need one sample with minimum 80 μm coating thickness and a second sample with maximum 40 μm coating thickness. For each sample, take two reference measurements. Offset calibration will be active only when these two conditions are satisfied: at least factor of two between thinnest and thickest coating, at least four reference measurements.

The result of the calibration is displayed in the calibration report (see below)

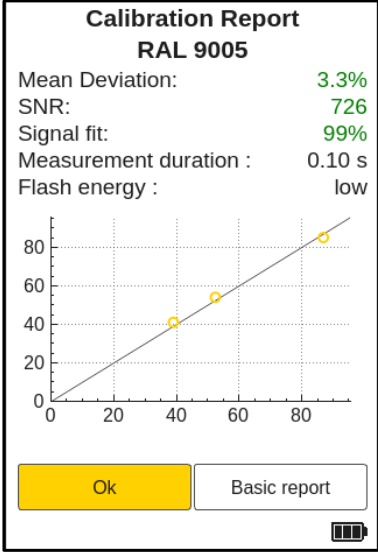
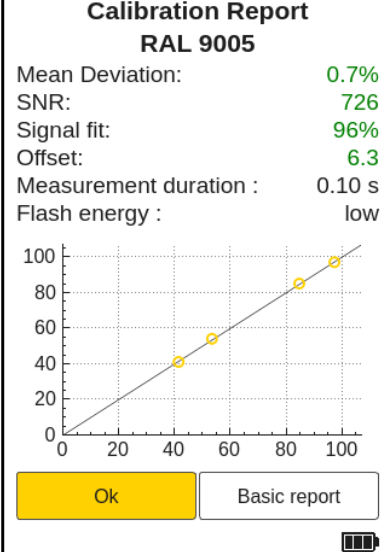
	
<p>Calibration report for a standard calibration (no offset).</p>	<p>Calibration report for an offset calibration, showing the offset value (in this example $-6.3 \mu\text{m}$). As a rule of thumb, the absolute offset value should not be larger than the minimum coating thickness used in the application. Both positive and negative offset values are allowed.</p>

9. Measurement

When the dedicated application and block have been chosen and the calibration has been made, the measurement series for the coating samples can be performed.

Make sure that the appropriate application has been selected in the application menu ([see section 8.4.](#)).

Hold the coatmaster® Flex as steadily as possible at a distance of approximately **5 cm** from the sample (see Figure 52: *Measurement*).

The measured surface is in the middle of the red circles and is approximately 2 mm^2 in diameter.

The measurement process is started by pressing the trigger button . When pressing the trigger button to conduct a measurement, a light impulse is released.



Figure 57: *Measurement*

To display a trend chart for your measurements for the current block, use the down arrow key \downarrow in the input panel. ([see section 7.2.](#))

Use the up arrow key \uparrow to return to the previous main menu showing the numeric display.

The chart graphically shows the trend of the last 20 measurements for the selected block.

If a measurement is outside the range bounds, it will not be displayed on the trend chart!

The vertical axis measurement values are displayed in the chosen units ([see section 8.1.4.](#)).

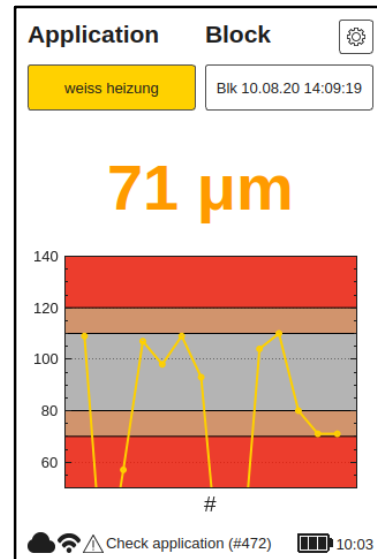

Figure 58: Trend chart



If the part to be measured is moving, keep up with the movement of the part, so that the relative movement between the part and the coatmaster® Flex is as small as possible, thus ensuring a stable measurement.



10. Data Transfer/Cloud

Now that you have made a set of measurements, you may want to process and further analyze the recorded data. This can be done by accessing your coatmaster® Flex server.

10.1. Login

For a cloud server, you must log in to the coatmaster® cloud on your computer via the Internet to access the data. Alternatively, if you are using a coatmaster® local server, connect your computer to the local server Wi-Fi ([see section 7.7.](#)). Proceed as follows to access to connect to your server:

Depending on your coatmaster® Flex server, select the following URL to connect to your server:

Server	URL
Europe	http://coatmaster.cloud
US	http://useast.coatmaster.cloud
China	http://ningxia.coatmaster.online
Local server	http://10.10.0.1:9080
Custom servers	Enter the custom IP address.

Login with the provided **Username** and **Password** (i.e. license key and activation code). Validate your entries by clicking the Login button.

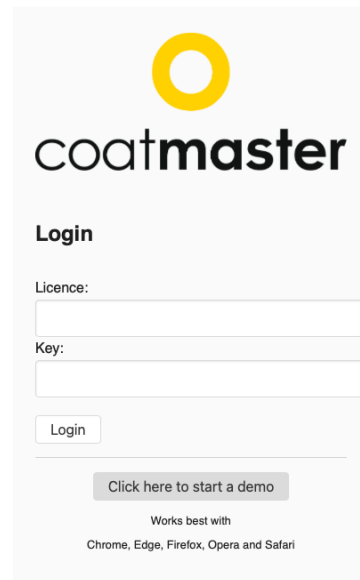

Figure 59: Cloud login

You will automatically be directed to the home display of the coatmaster® cloud website, which has four main menu buttons on the upper left side (Figure 47: *Cloud main menu*):

- APPLICATIONS
- MONITOR
- TREND
- EXPORT
- SETTINGS
- HELP
- LIBRARY

On the lower left side, you can choose the language (Bulgarian, Czech, German, Greek, English, Spanish, Estonian, Finnish, French, Hebrew, Indonesian, Italian, Japanese, Korean, Polish, Portuguese, Romanian, Russian, Slovenian, Serbian, Thai, Turkish, Vietnamese, Indian, Chinese) or Logout.



For further an more details instruction, you can download the latest, complete coatmaster® Flex WEB UI manual from our website.

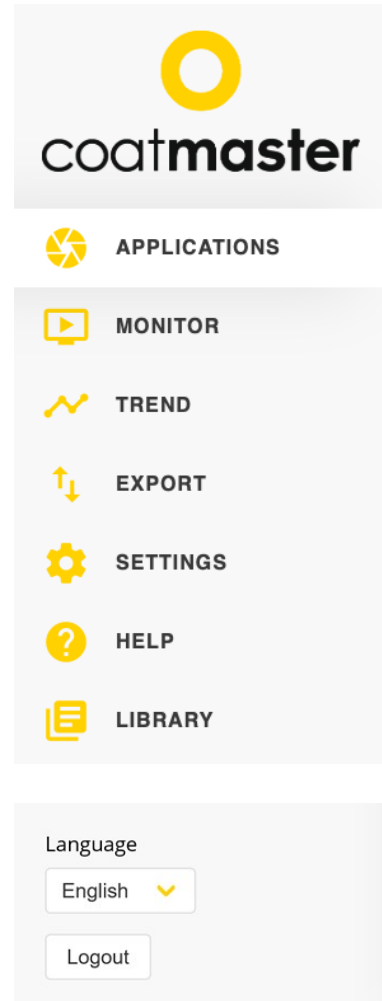

Figure 60: *Cloud main menu*

10.1.1. Applications

The application menu in the coatmaster® cloud displays the available applications. The list provides details of the number of blocks and measurements per application.

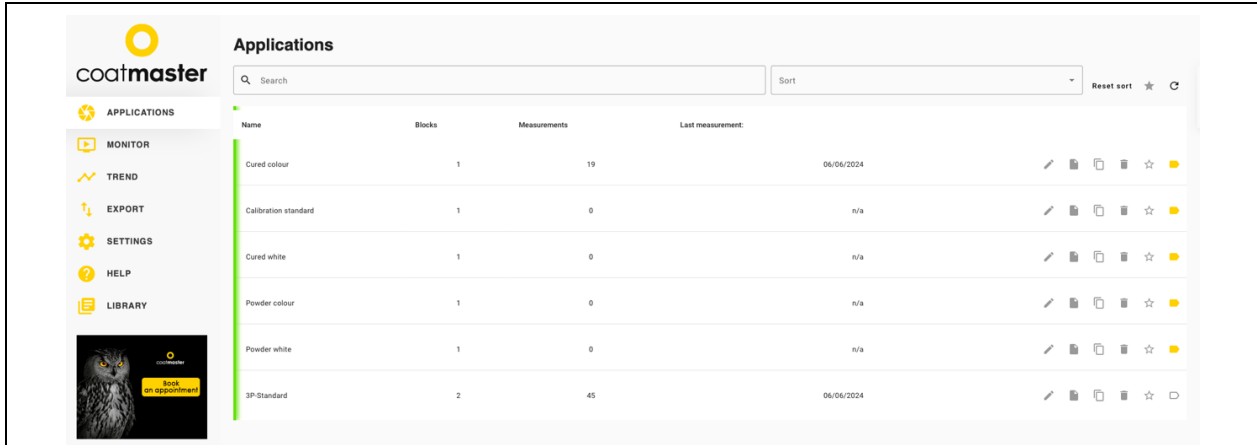

Figure 61: Cloud --application menu

To select an application, click on one of the applications in the list. You will automatically be directed to the TREND menu.

10.1.2. Monitor

Before you can review the trend chart of the application, which displays the measured thickness versus the time, you must select a block. Click on the block drop-down menu above the chart and select the desired block. To display the selected block, press the 'Refresh' button to reload the graph.

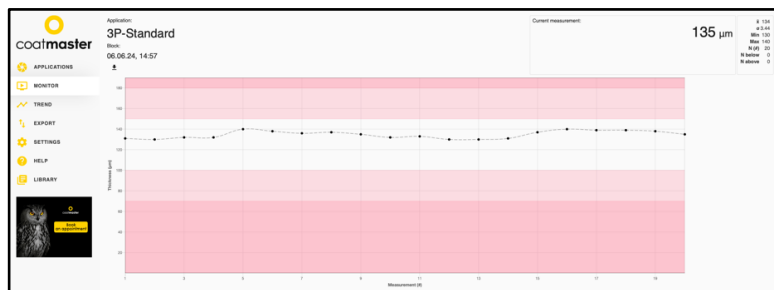
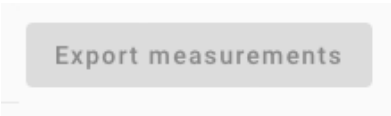

Figure 62: Cloud - monitor menu with block selection

To download the current block, simply click on



A prompting message will enable you to save or open the corresponding Excel file.

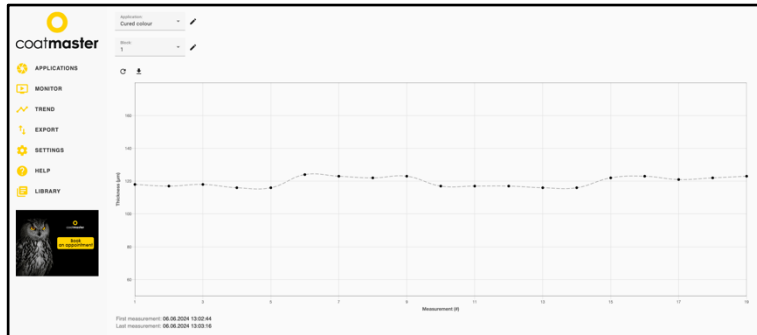

Figure 63: Cloud - monitor menu with chart

10.1.3. Export

Within the export menu of the coatmaster® cloud, you can select dedicated data and download it to your computer.

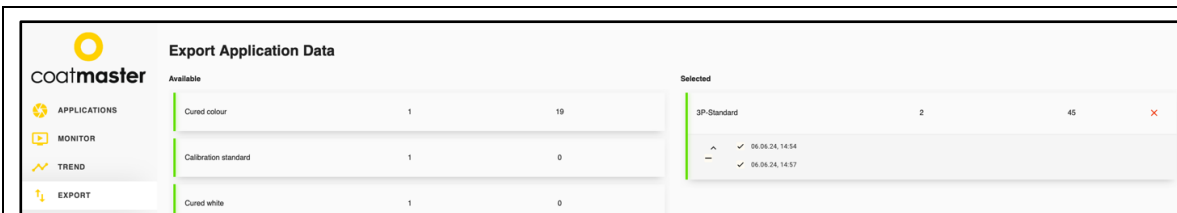

Figure 64: Cloud - export menu - select application

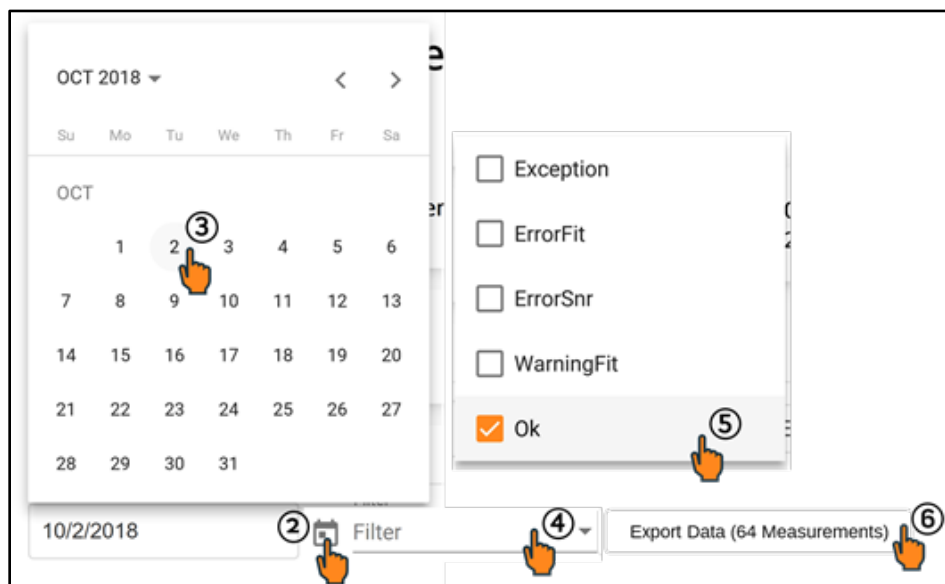

Figure 65: Cloud - export menu - limiting data select

① Click on the desired application.

The selected application will be copied to the export list in the right half of the window. You can remove the selected applications by clicking on the red cross (see Figure 64: *Cloud - export menu - select application*).

To limit your data selection, choose a start date for the data export. Click on the calendar icon ② and select the start date ③ in the calendar menu. You can also enter the start date in the corresponding field by using the format MM/DD/YYYY (MM = number of the month, DD = number of the day, YYYY = Year)

Additionally, you can apply one or more filters to select dedicated measuring data using ④ and ⑤.

Validate your selection and download the chosen data by clicking on the 'Export Data' button ⑥. A prompt message will enable you to save or open the corresponding Excel file.

10.1.4. Help

From the 'Help' menu, you can access further support information.

Please contact our Technical Support hotline first (contact details on page 2).



11. Troubleshooting and Best Practice

11.1. Error Messages

Error Messages	Description <ul style="list-style-type: none"> • Corrective measure
Cloud 	Did not receive a response from the cloud. <ul style="list-style-type: none"> • Check Internet status and perform a network diagnosis with 'Troubleshooter' (see section 8.1.1.). • Check the WLAN signal on the router. In the absence of a signal, reconnection of cables is required. If this is the case, reboot the router by switching the power off/on as necessary (see section 7.). • Check the status of your local Wi-Fi network.
Fit	Signal of sample does not match the application. <ul style="list-style-type: none"> • Select appropriate application (see section 8.4.). • If the application was working previously, look for dirt on the lens or flash. For cleaning, see section 13.1.
SNR	Signal-to-noise ratio is too low. Either <ul style="list-style-type: none"> • use an application with a higher flash power (see section 8.4.) or • move the device closer to the sample. For the measuring distance, see section 9.
Bounds	The measured thickness is outside the valid thickness limits set for the application. <ul style="list-style-type: none"> • Sample does not meet the defined quality limits; set the appropriate quality limits (bounds) (see section 8.4.4.9.).

Table 7: Error messages and corrective measures

11.2. Error Codes

Technical Errors	Description <ul style="list-style-type: none"> • Corrective measure
0	Received an 'Error' message from the cloud when measuring. <ul style="list-style-type: none"> • Check the Internet status and perform a network diagnosis with 'Troubleshooter' (see section 8.1.1.).
1	Wrong parameter. <ul style="list-style-type: none"> • Contact the Technical Support (details on page 2) for further assistance.
2	No data acquisition (DAQ) board. <ul style="list-style-type: none"> • Contact the Technical Support (details on page 2) for further assistance.
3	Data acquisition (DAQ) busy. <ul style="list-style-type: none"> • Contact the Technical Support (details on page 2) for further assistance.
4	Flash generator timeout. <ul style="list-style-type: none"> • Contact the Technical Support (details on page 2) for further assistance.
5	Data acquisition (DAQ) error. <ul style="list-style-type: none"> • Contact the Technical Support (details on page 2) for further assistance.
6	Raw data process error <ul style="list-style-type: none"> • Contact the Technical Support (details on page 2) for further assistance
7	No light pulse detected. <ul style="list-style-type: none"> • Check whether you have selected the right energy level for your application (see section 8.4.). See Application menu. • Contact the Technical Support (details on page 2) for further assistance.
8	Wrong light pulse timing. <ul style="list-style-type: none"> • Contact the Technical Support (details on page 2) for further assistance.
9	Cannot open file. <ul style="list-style-type: none"> • Contact the Technical Support (details on page 2) for further assistance.
10	Cloud timeout. <ul style="list-style-type: none"> • Check your Wi-Fi settings. • Check the internet status and perform a network diagnosis with 'Troubleshooter' (see section 8.1.1.). • Contact the Technical Support (details on page 2) for further assistance.
11	Wrong message format. <ul style="list-style-type: none"> • Contact the Technical Support (details on page 2) for further assistance.
12	Http error. <ul style="list-style-type: none"> • Contact the Technical Support (details on page 2) for further assistance.
13	Unknown error. <ul style="list-style-type: none"> • Contact the Technical Support (details on page 2) for further assistance.
14	Unable to connect to Wi-Fi. <ul style="list-style-type: none"> • Check your Wi-Fi settings. • Check the internet status and perform a network diagnosis with 'Troubleshooter' (see section 8.1.1.). • Contact the Technical Support (details on page 2) for further assistance.
15	IR signal clipping. <ul style="list-style-type: none"> • Use a lower flash energy (that is in the case you are using White for color), select Non-White for your application. • If you measure on hot pieces, try to wait till the parts cool down. • Contact the Technical Support (details on page 2) for further assistance.
16	Photodetector signal clipping. <ul style="list-style-type: none"> • Contact the Technical Support (details on page 2) for further assistance.

17	Wrong acquisition parameter. <ul style="list-style-type: none"> • Contact the Technical Support (details on page 2) for further assistance.
119	Optimization start time not found. <ul style="list-style-type: none"> • Contact the Technical Support (details on page 2) for further assistance.
120	Photodiode cutoff not found. <ul style="list-style-type: none"> • Contact the Technical Support (details on page 2) for further assistance.
471	Fit error. <ul style="list-style-type: none"> • Check application • If the application was working previously, look for dirt on the lens or flash. • Contact the Technical Support (details on page 2) for further assistance.
472	Fit warning. <ul style="list-style-type: none"> • Check application • If the application was working previously, look for dirt on the lens or flash. • Contact the Technical Support (details on page 2) for further assistance.
995	Range based error. <ul style="list-style-type: none"> • Contact the Technical Support (details on page 2) for further assistance.
999	Failure in algorithm. <ul style="list-style-type: none"> • Contact the Technical Support (details on page 2) for further assistance.
9992	Theta matrix inconsistent. <ul style="list-style-type: none"> • Contact the Technical Support (details on p. 2) for further assistance.
9993	Negative slope. <ul style="list-style-type: none"> • Contact the Technical Support (details on p. 2) for further assistance.

Table 8: Error codes and corrective measures

11.3. Frequently Asked Questions (FAQs)

Keyword	Description Reason <ul style="list-style-type: none"> Corrective measure
No start	My coatmaster® Flex does not turn on. Battery almost empty. <ul style="list-style-type: none"> Recharge battery.
Sudden shut-down	My coatmaster® Flex immediately shuts down after triggering a flash. If it happens rarely, <ul style="list-style-type: none"> Leave it and restart the device. If it happens regularly, <ul style="list-style-type: none"> Return Flex to your service partner given on page 2.
Fan not running	The fan of my coatmaster® Flex is not running. Measurements will become unstable. <ul style="list-style-type: none"> Send the device back to your service partner (page 2) for repair.
Sudden flash without trigger	coatmaster® Flex triggers a flash or multiple flashes without pressing the trigger button. <ul style="list-style-type: none"> Strong magnetic field (i.e. spark of powder coating gun).
Unstable results	Unstable measurements or varying thickness values when using the coatmaster® Flex. <ul style="list-style-type: none"> coatmaster® Flex is too hot. Search for a cooler measuring environment, allow the coatmaster® Flex to cool down, and never leave the coatmaster® Flex in direct sunlight for an extended period of time. Parts to be measured are too far away. Follow the instructions regarding sample distance in section 9. Wrong flash intensity selected. Select the appropriate color in the calibration menu (see section 8.4).

Table 9: Frequently Asked Questions



11.4. Hotline

Technical Support for coatmaster® Flex: contact details on page 2



12. Storage and Transportation

To ensure that your coatmaster® Flex is always protected from dust, dirt, moisture and damage, always store the measurement device, router, and batteries safely in the transport case when not in use.

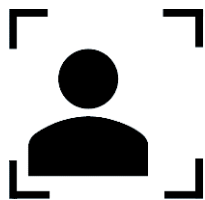

13. Maintenance and Repair

For any repair or service of the device, excluding light maintenance, please contact our Technical Support hotline (contact details on page 1).

Light maintenance: coatmaster® Flex needs to be inspected, at least weekly, for inlet filter cleanliness, and front glass transparency and cleanliness.

In case of any other tampering, or opening of the device, the warranty will immediately be terminated.

Table 9 gives you an overview of the items that need to be regularly maintained on your coatmaster® Flex:

Item	Description Level	Maintenance Level	Done by
Inlet filter	Regular maintenance	L1	User
Battery	Replace item when necessary	L1	User
Infrared Filter	Annual maintenance	L2	CSP
O-Ring	Annual maintenance	L2	CSP

Table 10: *Items to be maintained and maintenance level*

Maintenance Level:







Level 1 (L1): can be done by the user of the coatmaster® Flex.

Level 2 (L2): must only be done by a coatmaster service partner (CSP).

Level 2 maintenance by the user, or any technician except an authorized coatmaster service partner, is prohibited. In such a case, the warranty will immediately be terminated.

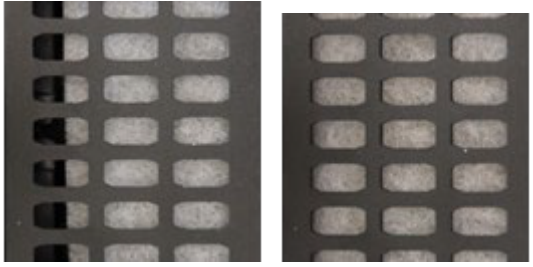
13.1. Replacement of the Inlet Filter

The inlet filter must be inspected, at least weekly, by the user of the coatmaster® Flex to avoid a malfunction of the device. If it is dirty, change the filter; otherwise, change the filter every second week or after 80 hours of use, whichever is earlier.

<p>Remove the bottom cover to examine the inlet filter of the coatmaster® Flex. The filter should be clean, as shown in Figure 65: <i>Inlet filter replacement</i>. If the inlet filter is dirty, please exchange the inlet filter for the one that has been provided with your delivery.</p> <p> Never reposition a reversed dirty filter in the filter holder since this will blow dust inside the coatmaster® and damage the device. Always use a clean, new filter.</p>	 <p>Figure 65: <i>Inlet filter replacement</i></p>
<p>Make sure that the filter is well positioned by pushing it toward the handle before closing the cover. The filter should cover the entire grid surface and no space should be visible after closing the filter cover, as shown in Figure 66: <i>Positioning of the inlet filter</i>.</p>	 <p> Wrong  Correct</p> <p>Figure 66: <i>Positioning of the inlet filter</i></p>
<p> Never attempt to clean the inlet and outlet filters with compressed air, since this will blow the dust particles inside the coatmaster® Flex and possibly push the filters away from their correct position.</p>	

13.2. Cleaning and Care

-  After cooling, clean the coatmaster® Flex with clean, dry, lint-free paper cloths. Never clean the front glass or the lens with alcohol-based cleaners!
- Do not clean the device with compressed air!**

13.3. Warranty

Your coatmaster® Flex is covered by a one-year warranty.

14. API-Interface Description

You will find the current API at:

https://coatmaster.com/fileadmin/bilder/coatmasterflex/coatmaster_Flex_API.pdf

Or scan the QR code:





coat**master**

measure up. contactless.

coat**master** AG
Flugplatzstrasse 5
CH-8404 Winterthur
+41 52 2120277
[info@coat**master**.com](mailto:info@coatmaster.com)
[www.coat**master**.com](http://www.coatmaster.com)